

TOOL STORAGE

Round Tooling | Dimensions | How To Order

Tool Storage Cart

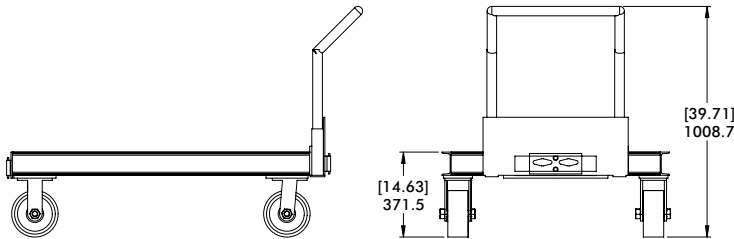
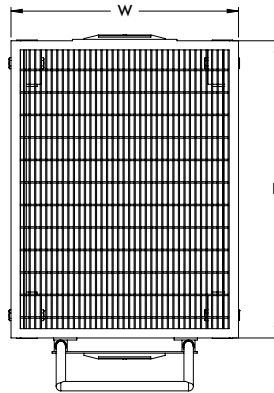

Base Model	Width			Length		
TC	36	36.00"	0.9 m	48	48.00"	1.2 m
Tool Storage Carts	48	48.00"	1.2 m	60	60.00"	1.5 m
				72	72.00"	1.8 m
				84	84.00"	2.1 m
				96	96.00"	2.4 m

Tool Hanger

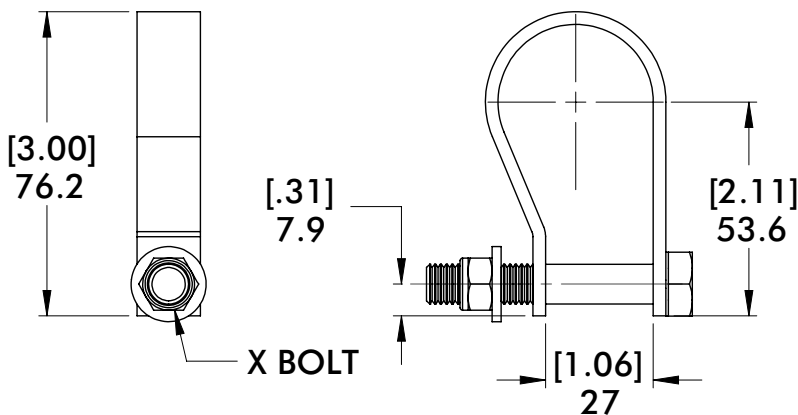

Material: Steel

Model Number	Weight
CPI-THR-516	91g [0.20 lb]

TOOL STORAGE

Round Tooling | Dimensions | How To Order

Tool Holder Strap



Model Number	Weight
CPI-SGM-TH-CABLE-08	68g [0.15 lb]

Tool Storage Can

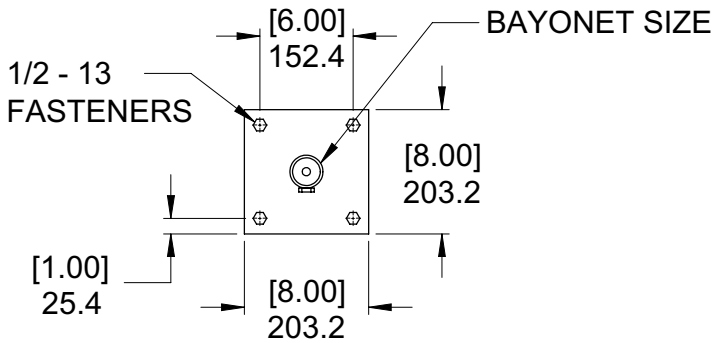

Material: Steel

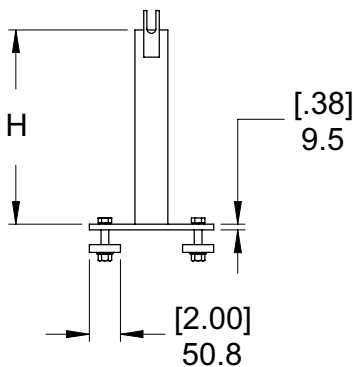







CPI - **TH** - **BF**

Base Model	Bayonet Size	Height
TH Tool Holder	150 1.5" 40 mm	6.5 6.5" 165 mm
	250 2.5" 60 mm	12.5 12.5" 318 mm
		18.5 18.5" 470 mm

VACUUM SOLUTIONS

Table of Contents

	Vaccum Cups	3
	Magnets.....	28
	EcoCup	29
	Vacuum Generation	31
	Spring Cup Mounts	37
	Double Blank Detector Mounts	46
	Manifolds.....	53

VACUUM PRODUCTS

DESTACO vacuum cups can be ordered in different types, sizes, materials and durometers to be used in a broad array of applications, ranging from sheet metal handling to plastics to glass.



DESTACO also provides vacuum cups for extreme temperatures and hot-forming applications

EcoCup™ is the world's first electric vacuum cup, creating vacuum without air. The EcoCup™ is ideal for pick-and-place applications of flat, rigid, non-porous parts, including plastic, glass, and other consumer goods with smooth, flat surfaces.



ARV® The original, patented Auto-Release Venturi offers users the fastest vacuum and blow-off in the industry with single line operation, integrated blow-off and standard silencer.

Destacker Double Blank Detectors (DBD) allows compliance to blanks within $\pm 15^\circ$ without needing to adjust the robot, automation or tooling.

