

Visual Selection Guide

ROBOHAND | Grippers, Slides, Rotaries



ABOUT DESTACO

Built on a Strong Foundation

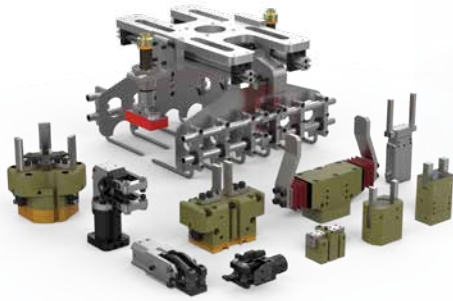

Gripping Solutions



Linear Positioning Solutions



Rotary Positioning Solutions



Clamping Solutions



CRL Central Research Laboratories
a DESTACO company

CRL Remote Handling Solutions



Robotic Tooling Solutions

DESTACO, a Dover company, is a global leader in the design and manufacture of high-performance automation, workholding and remote-handling solutions. The company serves customers in a variety of end-markets, including the automotive, life sciences, consumer packaged goods, aerospace, industrial and nuclear sectors.

Built on a legacy of more than 100 years, DESTACO offers a comprehensive portfolio of products designed to engineer precise movement, placement and control solutions that drive productivity and uptime for manufacturers around the world. The DESTACO family of products consists of industry-leading brands such as DESTACO Manual Clamps, Power Clamps, and End Effectors; CAMCO™ and Ferguson™ Indexers; Robohand™ Grippers; and CRL™ Manipulators and Transfer Ports.

DESTACO is based in Auburn Hills, Michigan, U.S.A. The company has more than 800 employees with 13 locations, in 9 countries, across the Americas, Europe and Asia.

DESTACO is part of Dover Corporation, a diversified global manufacturer with annual revenues of \$7 billion. The company delivers innovative equipment and components, specialty systems and support services through four major operating segments: Energy, Engineered Systems, Fluids, and Refrigeration & Food Equipment. Headquartered in Downers Grove, IL, (NYSE: DOV)

More information is available at destaco.com and dovercorporation.com

Focusing all of our Resources

New Product Development

DESTACO has dedicated resources to design and build the next generation of products and solutions

Customer and Technical Service

DESTACO has industry leading global support to address any product and application concerns you may have

Design Tools

DESTACO provides an extensive CAD library, sizing software, and online tools to support our global customers



Our Insight Working for You

Application Engineering

We utilize our expertise and complete portfolio of products to create solution that fit our customers' needs and applications

Custom Solutions

If our off-the-shelf solutions don't fit, we will partner with our customers to develop products that will



Grippers, Rotaries, and Linear Slide Solutions

Engineered Reliability

Destaco's Robohand products are engineered for reliability and long life to ensure maximum production uptime. These products are designed and machined for precise repeatability with minimal maintenance.

Markets



Applications

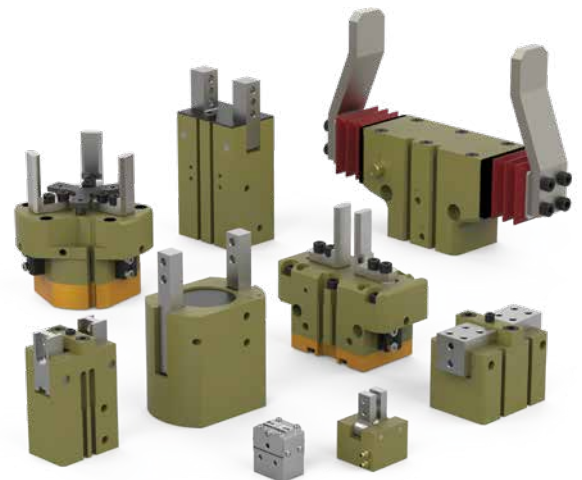

Parallel & Angular Pneumatic Grippers



Electric Parallel Grippers



Rotary Actuators



Feed Escapements



Linear Slides

GRIPPERS/SLIDES/ROTARIES

CLICK OR SCAN
To view the full
PDF catalog on
these products



Table of Contents

Introduction:

North American Xpress Program	5
European Xpress Program	6
Clean Room Solutions.....	9
Robotic Tooling Solutions	10
Modular Mounting Solutions/DirectConnect™	14
Product Sizing and Application Charts	18



Electric Grippers 38



Precision Grippers 40



General Industrial Grippers 52



Heavy Duty Grippers 72



OEM Machine Builder..... 80



3-Jaw Parallel Grippers 84



Angular Grippers..... 94



Specialty Grippers 102



Rotary Actuators 104



Linear Slides..... 110

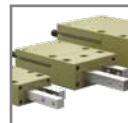

Feed Escapements..... 126

NORTH AMERICAN XPRESS PROGRAM

A Full Line of Automation Products to Meet Your Application Needs Quickly













ON OUR MOST POPULAR PRODUCTS



To choose the best and most cost-effective automation solution for your application please contact your DESTACO sales representative or DESTACO customer service.

Product listed below are for North American Market only.





Parallel Grippers

				
		SIZE	STROKE [mm]	FORCE [N]
	RDH/RTH Series 2 & 3 Jaw Impact Resistant Shielded Gripper	1, 2, 3, 4, 5 -L Stroke option	4.0-26	125-675
	RP Series Rugged Impact Resistant Gripper	5, 10, 11, 12, 15	4.0-12.7	156-311
	RPL/RPLC Series Zero Side Play, High Repeatability Gripper	1, 2, 3, 4 (C)=Clean Room Version	6.4-25.4	116-160
	RPM/RPMC Series Low Friction Micro Gripper	1, 2, 3, (C)=Clean Room Version	4.1-6.3	36
	DPG Series Modular Multi-Part Sensing Gripper	10M-2	12.7	222
	DPW Series Wide Parts/ Long Finger Gripper	250, 375, 500	19.05-63.5	222-800
	RPW Series Wide Parts/ Long Finger Gripper	625	50.8-88.9	1068

Angular Grippers

				
		SIZE	ANGLE	FORCE [N]
	RA Series Low Cost Small Size Angular Gripper	RA-5	15° (per finger)	89

Rotary Actuators

				
		SIZE	ANGLE	PAYLOAD [Kg]
	RR Series High Torque Compact Rotary Actuators	18, 28, 36	0-180°	0.45-3.6

EUROPEAN XPRESS PROGRAM

A Full Line of Automation Products to Meet Your Application Needs Quickly



ON OUR MOST POPULAR PRODUCTS

To choose the best and most cost-effective automation solution for your application please contact your DESTACO sales representative or DESTACO customer service.

Product listed below are for European Market only.



SIZE















STROKE [mm]



FORCE [N]

2-Jaw Parallel Grippers

	HEAVY DUTY	RDH Series Impact Resistant Shielded Gripper	All Sizes	4-70	361-28002
		2P Series Precision Cylindrical Gripper	All Sizes	10-30	109-3043
		REP-2 Series Cylindrical Shielded Gripper	All Sizes	10-30	480-3351
		DGC Series Precision Long Stroke Gripper	All Sizes	20-60	474-2318
		DPG Series Modular Gripper	All Sizes	6.4-25.4	222
		DPW Series Wide Parts/ Long Finger Gripper	All Sizes	19.1-63.5	222-800
	HEAVY DUTY	RPW Series Wide Parts/ Long Finger Gripper	625, 750	19.1-114.3	222-2091
	HEAVY DUTY	RP Series Rugged Impact Resistant Gripper	All Sizes	4.0-50.8	40-3336
		DPL Series Long Stroke, Low Profile Gripper	All Sizes	40-140	811-2035
		CP Series Compact Gripper	All Sizes	4-32	10-2749
		RPL/RPLC Series Zero Side Play, High Repeatability Gripper	All Sizes (C)=Clean Room	6.4-25.4	116-160
		RPM/RPMC Series Low Friction Micro Gripper	All Sizes (C)=Clean Room	3.2-6.3	36
		RDE Series Water Immersion Gripper	Contact DESTACO for More Information		

EUROPEAN XPRESS PROGRAM

A Full Line of Automation Products to Meet Your Application Needs Quickly











ON OUR MOST POPULAR PRODUCTS







To choose the best and most cost-effective automation solution for your application please contact your DESTACO sales representative or DESTACO customer service.

Product listed below are for European Market only.

3-Jaw Parallel Grippers

		 SIZE	 STROKE [mm]	 FORCE [N]
    	HEAVY DUTY RTH Series Impact Resistant Shielded Gripper	All Sizes	4-20	579-4562
	3P Series Precision Cylindrical Gripper	All Sizes	10-30	107-2030
	REP-3 Series Cylindrical Shielded Gripper	All Sizes	10-30	469-3268
	PPC Series Thru-Hole Gripper	All Sizes	10-30	896-4332
	RTE Series Water Immersion Gripper	Contact DESTACO for More Information		

Angular Grippers

		 SIZE	 ANGLE	 FORCE [N]
   	RUA Series Cylindrical Gripper	All Sizes	15.9-19.1° (per finger)	313-3941
	DCT-CT Series 180° Jaw Opening Gripper	All Sizes	90° (per finger)	32-893
	RA Series Compact Gripper	RA-6	15° (per finger)	71-801
	FUA Series Food Gripper	All Sizes	35° (per finger)	9-32

EUROPEAN XPRESS PROGRAM

A Full Line of Automation Products to Meet Your Application Needs Quickly



ON OUR MOST POPULAR PRODUCTS

To choose the best and most cost-effective automation solution for your application please contact your DESTACO sales representative or DESTACO customer service.

Product listed below are for European Market only.

Rotary Actuators

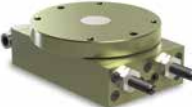

		SIZE	ANGLE	PAYLOAD [Kg]
	RR Series Light-Duty High Torque Compact Rotary Actuators	All Sizes	0-180°	0.45-1.3
 HEAVY DUTY	RR Series Heavy-Duty High Torque Compact Rotary Actuators	All Sizes	0-180°	3.6-91



Feed Escapements

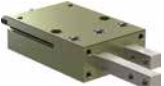

		SIZE	STROKE [mm]	PARTS ESCAPED
	RFE Series 2-Finger Actuation	All Sizes	16-32	85-150 (per minute)

Tool Changers and Compliance



		SIZE	PORTS	PAYLOAD [Kg]
 HEAVY DUTY	RQC/RTP Series Heavy-Duty Tool Changer	All Sizes	19 pin Electrical and 6 Pneumatic Ports	90-550
	QC/TP Series Tool Changer	All Sizes	12-15 pin Electrical and 4 Pneumatic Ports	30-150
	CH Series Horizontal Compliance	All Sizes	N/A	2-40



AU Series
Resettable Emergency
Stop Module

Contact DESTACO for More Information

CLEAN ROOM RATED SOLUTIONS

Grippers/Slides/Rotaries | Product Overview

DESTACO's Clean Room Rated Solutions are geared toward laboratory, semiconductor, medical, and food handling type environments. Many of our pneumatic products include a scavenge or purge port. These extra ports create internal vacuum or pressure to control contaminants escaping into the environment or prevent de-greaser or other chemicals penetrating our product.

Solutions include:

- Diverse line-up of products for class 10/100 cleanroom environments
- Manufactured with corrosion-resistant materials for use with de-ionized water
- Customized solutions available with food and medical grade lubricants, stainless steel, and nickel-plated materials to meet your application requirements.

Electric Parallel Grippers			
Rating	RPE-100	DPE-200	DPE-400
ISO 4 (Class10)	☉☉		
ISO 5 (Class100)	☉		☉
ISO 6 (Class1,000)	☉	☉	☉
ISO 7 (Class10,000)	☉	☉	☉
ISO 8 (Class100,000)	☉	☉	☉

Pneumatic 2-Jaw and 3-Jaw Grippers									
Rating	RPMC	RPLC	DPDS	DPDL	DPG	DPP	RDH	RTH	DCT
ISO 4 (Class10)	☉☉	☉☉	☉☉						
ISO 5 (Class100)	☉☉	☉☉	☉☉	☉☉	☉		☉☉	☉☉	☉
ISO 6 (Class1,000)	☉☉	☉☉	☉	☉	☉		☉	☉	☉
ISO 7 (Class10,000)	☉	☉	☉	☉	☉	☉	☉	☉	☉
ISO 8 (Class100,000)	☉	☉	☉	☉	☉	☉	☉	☉	☉

Linear Slides			
Rating	DLB	DLT	DLM
ISO 4 (Class10)			
ISO 5 (Class100)			
ISO 6 (Class1,000)	☉	☉	☉
ISO 7 (Class10,000)	☉	☉	☉
ISO 8 (Class100,000)	☉	☉	☉

Rotaries	
Rating	RR
ISO 4 (Class10)	
ISO 5 (Class100)	
ISO 6 (Class1,000)	
ISO 7 (Class10,000)	
ISO 8 (Class100,000)	☉

- ☉ Standard Clean Room
- ☉☉ With use of Scavenge Port

Note: All products tested using Krytox™ Grease. Please contact factory for individual test results and additional clean room requirements.

ROBOTIC TOOLING SOLUTIONS

CLICK OR SCAN
To view full catalog pages
on these product

Automatic Tool Changers | Features and Benefits

Automatic Tool Changers

Robotic Applications:

Perfect for those flexible/multiple tooling applications utilizing one Robot. This product was designed with exceptional repeatability, high rigidity & load capacity to make it ideal for any robotic application.

Automation Applications:

End effector tooling and interchangeable fixturing can be changed quickly and easily to accommodate many different styles of parts on the same assembly machine or machining center.

Highly Configurable, Modular Design (RQC/RTP):

The Modular RQC series easily accommodates up to (4) optional modular interfaces, offering a high level of flexibility.

Mounting Information

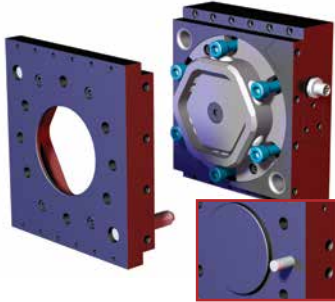

RQC Robot Plate Adaptor
Counterbored holes for mounting with a dowel pin hole, a raised boss for location and a ISO9409-1 mounting pattern.

Back Side of RQC

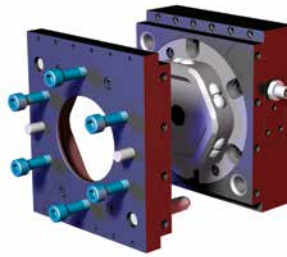

RTP Tool Plate Adaptor
Tapped holes, two dowel pin holes for accurate location of payload and a ISO9409-1 mounting pattern.



QC Robot Plate Adaptor
has counterbored holes for mounting and two dowel pins for hole location (size 30 has pilot boss).



TP Tool Plate Adaptor
has counterbored holes for mounting and two dowel pins for hole location (size 30 has pilot boss).



RHC Robot Plate Adaptor
mounts with screws from behind or through the front and locates with dowel pins for accuracy.



RHC Tool Plate Adaptor
mounts payload with screws from behind or through the front and locates with dowel pins for accuracy. Protect cone surfaces from debris to insure proper positioning.



Compliance Device | Features and Benefits

Flexibility of the Tool:

Cylindrical Horizontal compliance devices are used for inserting components that may be misaligned with the tool. They allow a horizontal displacement that compensates for part placing inaccuracies.

For Precision Applications:

High quality components allows for centering repeatability from 0.02mm and angular repeatability from $\pm 10^\circ$.

Harsh Environments:

Enclosed design allows them to be used in harsh environments.

Spring Assist:

Optional spring assist allows for use in single acting mode.



Mounting Information



CH Horizontal Compliance
The compliance is located using a pilot boss and a dowel pin and assembled using 4 or 6 through body screws.

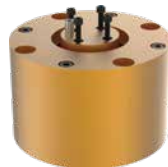

Tool Mounting
Tooling is located using a centering and a dowel pin and assembled using 4 screws.



See page 5-8 for product availability in your region.



CLICK OR SCAN

To view full catalog pages on this product

RQC/RTP SERIES

Automatic Tool Changers | Technical Information

RQC-200/RTP-200

Combined Weight: 3 Kg [6.7 lb]
Max. Payload: 90 Kg [200 lb]
Max. Moment: 810 Nm [7200 in-lb]

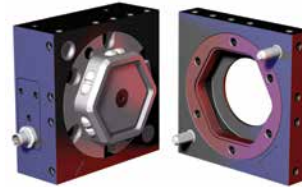
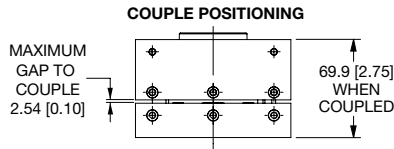

RQC-200 Robot Plate
RTP-200 Tool Plate



See page 5-8 for product availability in your region.

RQC-400/RTP-400

Combined Weight: 4.7 Kg [10.4 lb]
Max. Payload: 180 Kg [400 lb]
Max. Moment: 1580 Nm [14000 in-lb]

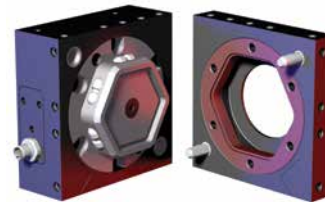
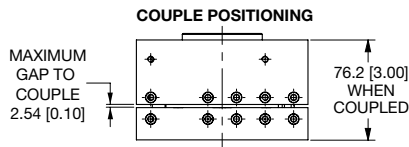

RQC-400 Robot Plate
RTP-400 Tool Plate

RQC-800/RTP-800

Combined Weight: 7.1 Kg [15.8 lb]
Max. Payload: 360 Kg [800 lb]
Max. Moment: 2490 Nm [22000 in-lb]

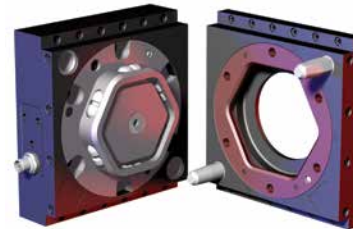
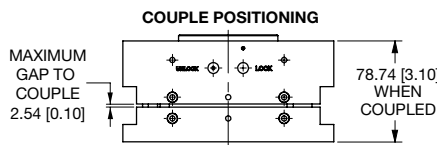

RQC-800 Robot Plate
RTP-800 Tool Plate

RQC-1200/RTP-1200

Combined Weight: 8.3 Kg [18.4 lb]
Max. Payload: 550 Kg [1200 lb]
Max. Moment: 3390 Nm [30000 in-lb]

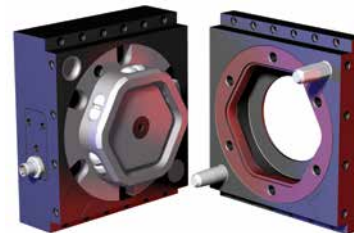
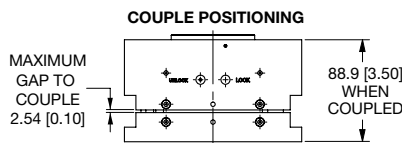

RQC-1200 Robot Plate
RTP-1200 Tool Plate

RQC-2400/RTP-2400

Combined Weight: 30 Kg [66.1 lb]
Max. Payload: 1089 Kg [2400 lb]
Max. Moment: 7000 Nm [61955 in-lb]

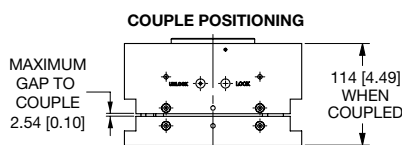

RQC-2400 Robot Plate
RTP-2400 Tool Plate

QC/TP, RHC SERIES

CLICK OR SCAN
To view full catalog pages
on these product

Automatic Tool Changers | Features and Benefits

QC Series Tool Changers



See page 5-8 for
product availability
in your region.

QC-30
Robot
Plate



TP-30
Tool
Plate

Combined Weight: 0.34 Kg [0.75 lbs]
Max. Payload: 13.6 Kg [30 lbs]
Max. Moment: 22.6 Nm [200 in-lbs]

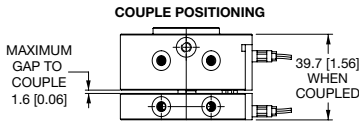

QC-60
Robot
Plate



TP-60
Tool
Plate

Combined Weight: 1.27 Kg [2.8 lbs]
Max. Payload: 27 Kg [60 lbs]
Max. Moment: 88.1 Nm [780 in-lbs]

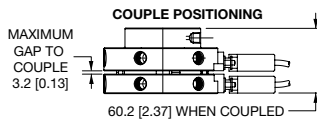

QC-60-10P
Robot
Plate



TP-60-10P
Tool
Plate

Combined Weight: 1.27 Kg [2.8 lbs]
Max. Payload: 27 Kg [60 lbs]
Max. Moment: 88.1 Nm [780 in-lbs]

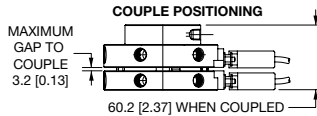

QC-150
Robot
Plate



TP-150
Tool
Plate

Combined Weight: 3.2 Kg [7.1 lbs]
Max. Payload: 68 Kg [150 lbs]
Max. Moment: 215 Nm [1900 in-lbs]

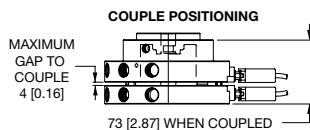

RHC Series Tool Changers



RHC-1-R
Robot
Plate



RHC-1-T
Tool
Plate

Combined Weight: 0.29 Kg [0.63 lbs]
Max. Payload: 9 Kg [20 lbs]
Max. Moment: 28 Nm [250 in-lbs]

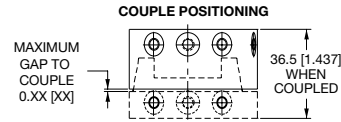

RHC-2-R
Robot
Plate



RHC-2-T
Tool
Plate

Combined Weight: 0.82 Kg [1.81 lbs]
Max. Payload: 59 Kg [130 lbs]
Max. Moment: 136 Nm [1200 in-lbs]

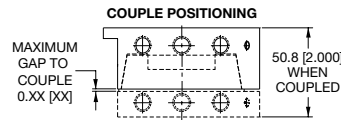

RHC-4-R
Robot
Plate



RHC-3-T
Tool
Plate

Combined Weight: 3.1 Kg [6.8 lbs]
Max. Payload: 136 Kg [300 lbs]
Max. Moment: 1017 Nm [9000 in-lbs]

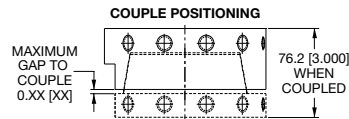

RHC-4-R
Robot
Plate



RHC-4-T
Tool
Plate

Combined Weight: 11 Kg [24.3 lbs]
Max. Payload: 454 Kg [1000 lbs]
Max. Moment: 2825 Nm [25000 in-lbs]

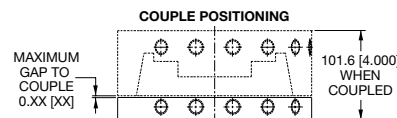

ROBOTIC TOOLING SOLUTIONS

Tool Changer Docking Station

DESTACO offers custom and standard Docking Stations to fit customers needs. Please contact DESTACO Sales for more information.

Key Features:

- Allows for quick changing of tooling
- Reducing machine down-time
- Safely stores tooling when not in use
- Standard or custom stations

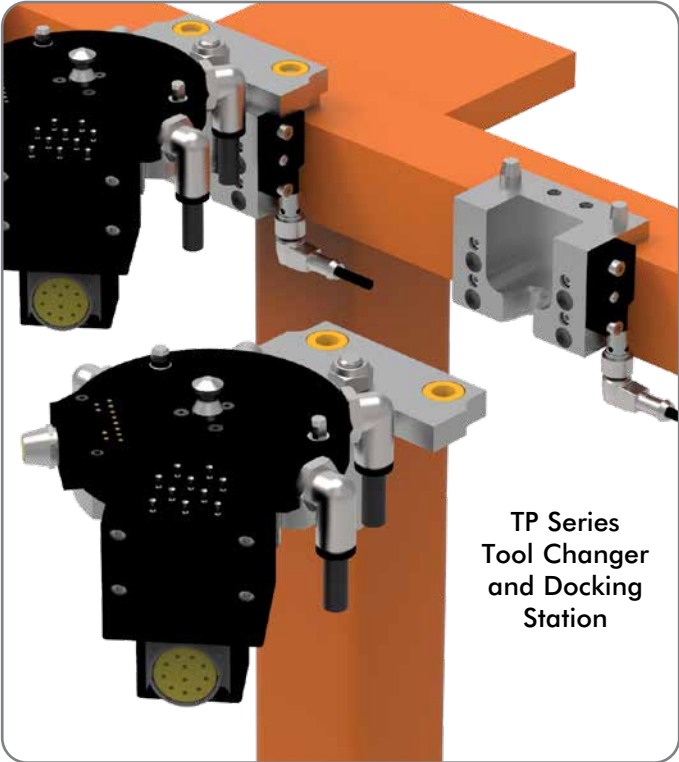
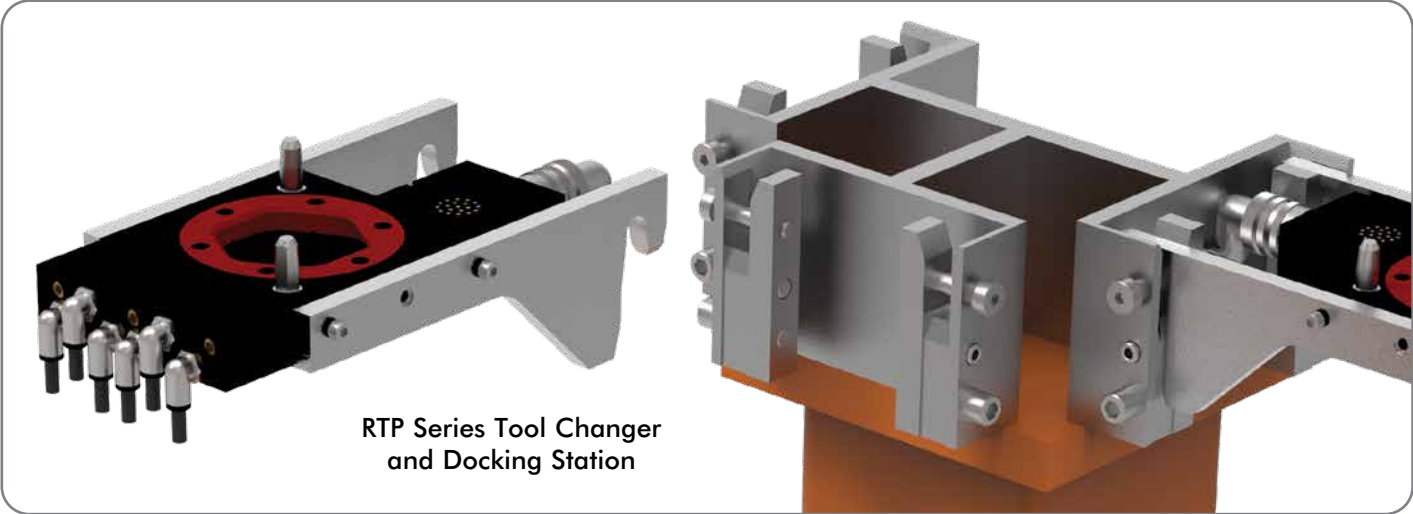

MODULAR MOUNTING SOLUTIONS

Grippers/Slides/Rotaries | Product Overview

DESTACO's modular automation systems feature DIRECTCONNECT™ technology, allowing all components of the system—base slides, block thrusters, thruster slides, grippers, and mounting stanchions—to be mounted together quickly and easily without any adapter plates.

- Reduces engineering design
- Saves \$\$\$ with modular solutions
- Change device orientations quickly
- Eliminates Adapter Plates

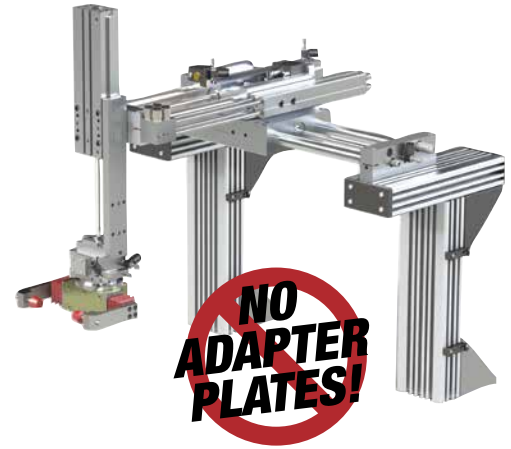

Modular DIRECTCONNECT Mounting Style Examples:

Look for more examples of each main section of the catalog. This is a sample of configurations we offer. Custom solutions also available.

Pick & Place

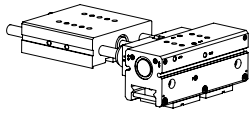

DLT Base Slide to
DPP Parallel Gripper

Place & Place

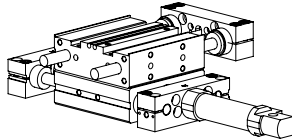

DLB Base Slide to
DLT Linear Slide

Place & Place

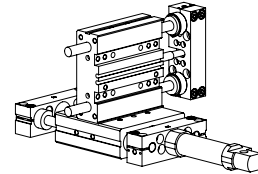

DLB Base Slide to
DLT Linear Slide

Connect Different Sizes & Styles

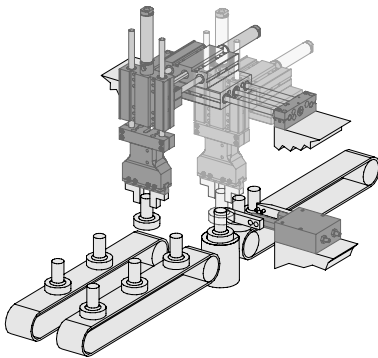

Configure in Multiple Orientations

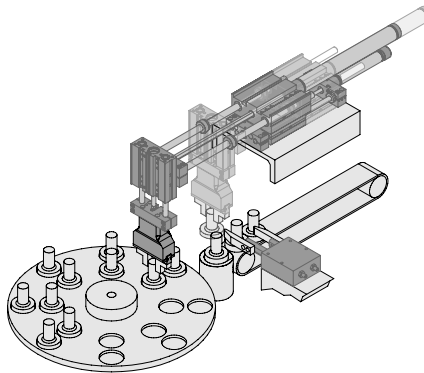

Look for the DIRECTCONNECT Logo

Product Series beginning with the letter D have a DIRECTCONNECT option, with a few exceptions.

DIRECTCONNECT™

HOW TO MAKE A DIRECTCONNECT™ MOUNT

Grippers/Slides/Rotaries | Product Overview

The DIRECTCONNECT Modular Compatibility Chart (on the next page) shows all the products that can easily connect together without adapter plates. Simply locate your first product along the horizontal axis of the top of chart, then locate the second product along the vertical axis on the left side of the chart. If a connection can be made, a mounting pattern will be shown.

DIRECTCONNECT Modular Compatibility Example:

Shown below, a DLB-10,12,16 Base Slide connecting to a DLT-10,12,16 Linear Thruster. Units may connect on different faces of the unit. Please refer to individual datasheets for DIRECTCONNECT mounting surfaces.

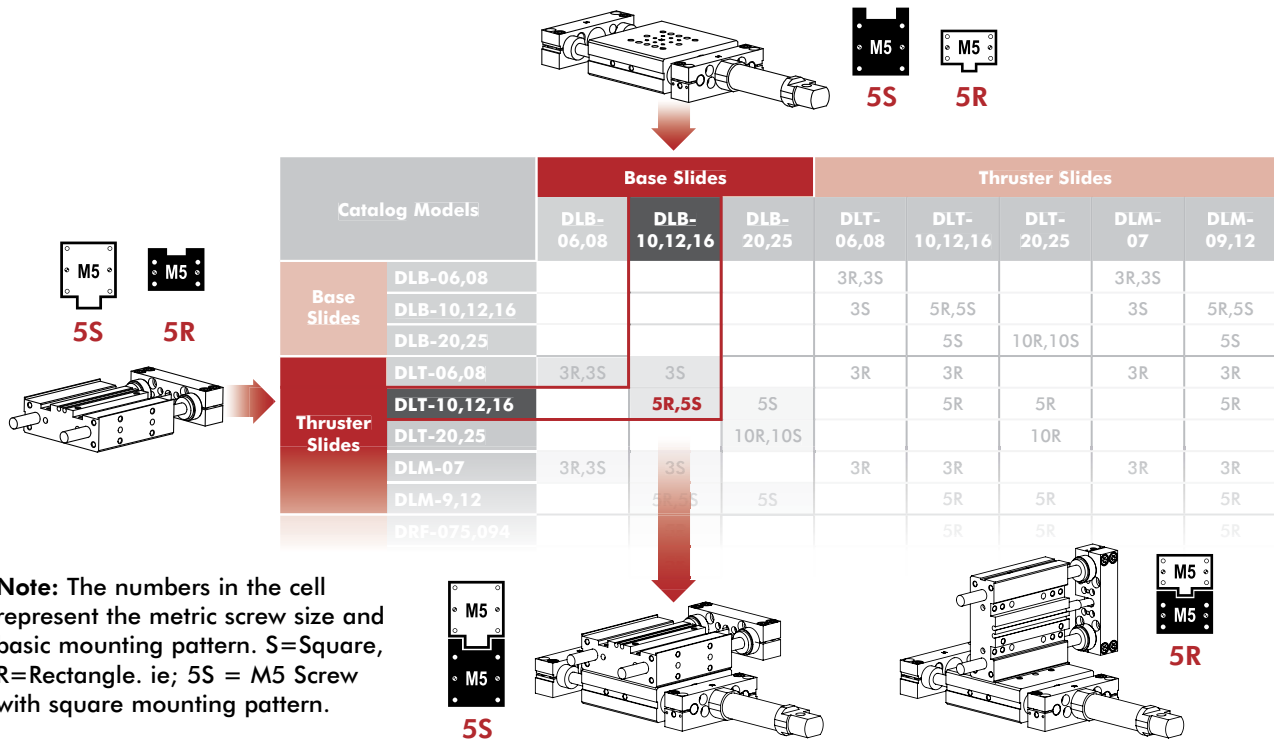

DirectConnect Mounting Surface Example:

Locate matching DIRECTCONNECT mounting pattern icons on the products dimensional drawings to determine what surface faces can be connected to. Corresponding mates equal a DIRECTCONNECT connection.

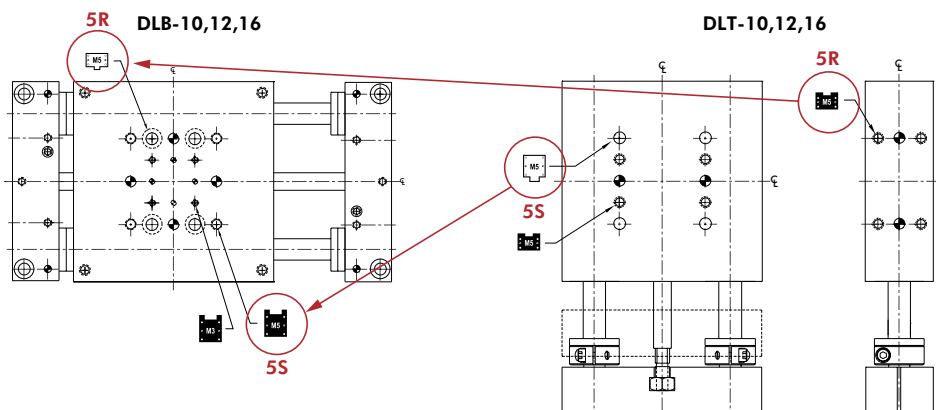

DIRECTCONNECT™ MODULAR COMPATIBILITY CHART

Grippers/Slides/Rotaries | Product Overview

DESTACO's modular automation systems feature DirectConnect™ technology, allowing all components of the system—base slides, block thrusters, thruster slides, and grippers—to be mounted together quickly & easily without any adapter plates. Look for matching icons on product datasheets for mounting compatibility.

Simply locate your first product along the horizontal axis of the top of chart, then locate the second product along the vertical axis on the left side of the chart. If a connection can be made, a mounting pattern will be shown.

Note: The numbers in the cell represent the metric screw size and basic mounting pattern. S=Square, R=Rectangle. ie; 5S = M5 Screw with square mounting pattern.

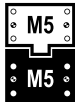
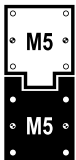

M5 (S)quare M5 (R)ectangle

Catalog Models		Base Slides		
		DLB-06&08	DLB-10,12&16	DLB-20&25
Base Slides	DLB-06 & 08			
	DLB-10, 12 & 16			
	DLB-20 & 25			
Thruster Slides	DLT-06 & 08	3R,3S	3S	
	DLT-10, 12 & 16		5R,5S	5S
	DLT-20 & 25			10R,10S
	DLM-07	3R,3S	3S	
	DLM-9 & 12		5R,5S	5S
Grippers	DGC		5R	
	DPG		5R	
	DCT-12, 16 & 25	3R		
	DCT-25		5R	
	DPDL-047 & 056	3R		
	DPDL-088 & 125		5R	
	DPDL-175 & 250			10R
	DPDS-047 & 056	3R		
	DPDS-088 & 125		5R	
	DPDS-175 & 250			10R
	DPL-25xx		5R	
	DPL-32xx & 40xx			10R
	DPP-10 & 14	3R		
	DPP-20		5R	
	DPP-28		5R	10R
	DPW-250	3R		
	DPW-375 & 500		5R	
	G110-08 & 011	3R		
G110-18 & 25		5R		
DPE-200		5R		
DPE-400			10R	

DIRECTCONNECT™ MODULAR COMPATIBILITY CHART

Grippers/Slides/Rotaries | Product Overview

Thruster Slides				
DLT-06&08	DLT-10,12&16	DLT-20&25	DLM-07	DLM-09&12
3R,3S			3R,3S	
3S	5R,5S		3S	5R,5S
	5S	10R,10S		5S
3R	3R		3R	3R
	5R	5R		5R
		10R		
3R	3R		3R	3R
	5R	5R		5R
	5R	5R		5R
3R	3R		3R	3R
	5R	5R		5R
3R	3R		3R	3R
	5R	5R		5R
		10R		
3R	3R		3R	3R
	5R	5R		5R
	5R	10R		5R
3R	3R		3R	3R
	5R	5R		5R
	5R	10R		5R
3R	3R		3R	3R
	5R	5R		5R
3R	3R		3R	3R
	5R	5R		5R
	5R	5R		5R
		10R		

PARALLEL GRIPPERS

Sizing and Application Chart

CLICK OR SCAN

To view full
catalog pages
on this product



	Series	Page #	Jaws		Basic Unit Dimensions mm [in]			Stroke mm [in]
			2 Jaws	3 Jaws	Length	Width	Height	0-6.3 [0-0.25] 6.3-12.7 [0.25-0.50] 12.7-19.1 [0.50-0.75] 19.1-25.4 [0.75-1.00] 25.4-31.8 [1.00-1.25] 31.8-38.1 [1.25-1.50] 38.1-44.5 [1.50-1.75] 44.5-50.8 [1.75-2.00] 50.8-57.1 [2.00-2.25] 57.1-63.5 [2.25-2.50] 63.5-69.8 [2.50-2.75] 69.8-76.2 [2.75-3.00] 76.2+ [3.00+]
Electric Grippers								
	DPE-200	39	●		67.9 [2.67]	28 [1.10]	128 [5.04]	●
	DPE-400	38	●		159.6 [6.28]	60 [2.36]	129.5 [5.10]	●
	RPE-100	39	●		32 [1.26]	40 [1.57]	94 [3.70]	●
Precision Grippers								
	6002P	40	●		72 [2.83]	60 [2.36]	77 [3.03]	●
	6002P-C	40	●		78 [3.07]	60 [2.36]	77 [3.03]	●
	8002P	40	●		91.6 [3.61]	80 [3.15]	78 [3.07]	●
	8002P-C	40	●		98.4 [3.87]	80 [3.15]	78 [3.07]	●
	11002P	40	●		126 [4.96]	110 [4.33]	106 [4.17]	●
	11002P-C	40	●		136 [5.35]	110 [4.33]	106 [4.17]	●
	1400P	40	●		165 [6.50]	140 [5.51]	137 [5.39]	●
	14002P-C	40	●		179 [7.05]	140 [5.51]	137 [5.39]	●
	16002P	40	●		194 [7.64]	165 [6.50]	169 [6.65]	●
	16002P-C	40	●		204 [8.03]	165 [6.50]	169 [6.65]	●
16502PGR	40	●		210 [8.27]	165 [6.50]	262 [10.31]	●	
	DGC-25	42	●		75 [2.95]	38 [1.50]	55 [2.17]	●
	DGC-45	42	●		95 [3.74]	42 [1.65]	70 [2.76]	●
	DGC-65	42	●		125 [4.92]	53 [2.09]	90 [3.54]	●
	GC-85	42	●		155 [6.10]	67.5 [2.66]	120 [4.72]	●
	GC-105	42	●		190 [7.48]	85.5 [3.37]	145 [5.71]	●
	DPL-2520	44	●		152 [5.98]	75 [2.95]	65 [2.56]	●
	DPL-2535	44	●		197 [7.76]	75 [2.95]	65 [2.56]	●
	DPL-3230	44	●		186 [7.32]	93 [3.66]	74 [2.91]	●
	DPL-3250	44	●		246 [9.69]	93 [3.66]	74 [2.91]	●
	DPL-4040	44	●		238 [9.37]	112 [4.41]	91 [3.58]	●
DPL-4070	44	●		328 [12.91]	112 [4.41]	91 [3.58]	●	
	DPP-10M-06	46	●		62.9 [2.48]	25 [0.98]	34.67 [1.36]	●
	DPP-10M-12	46	●		73.7 [2.90]	25 [0.98]	34.67 [1.36]	●
	DPP-14M-15	46	●		90.2 [3.55]	34 [1.34]	42.21 [1.66]	●
	DPP-14M-25	46	●		118.7 [4.67]	34 [1.34]	42.21 [1.66]	●
	DPP-20M-25	46	●		129 [5.08]	46 [1.81]	55.63 [2.19]	●
	DPP-20M-38	46	●		175.5 [6.91]	46 [1.81]	55.63 [2.19]	●
	DPP-28M-31	46	●		162.3 [6.39]	58 [2.28]	72.54 [2.86]	●
	DPP-28M-50	46	●		221.5 [8.72]	58 [2.28]	72.54 [2.86]	●





PARALLEL GRIPPERS

Sizing and Application Chart

CLICK OR SCAN

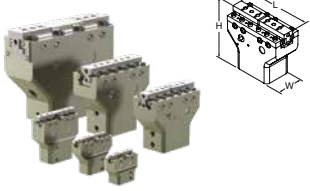
To view full
catalog pages
on this product

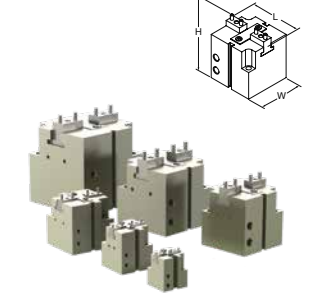
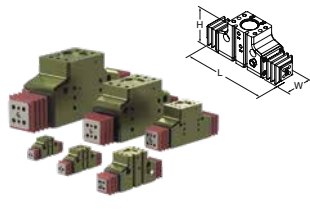
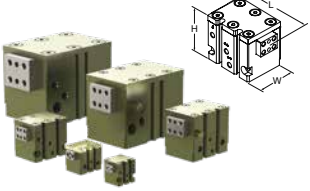

	Series	Page #	Jaws		Basic Unit Dimensions mm [in]			Stroke mm [in]
			2 Jaws	3 Jaws	Length	Width	Height	
Precision Grippers (cont.)								
	RP-50P	48	●		57 [2.24]	25.4 [1.00]	46.7 [1.84]	●
	RP-100P	48	●		83 [3.27]	25.4 [1.00]	59.4 [2.34]	●
	RP-25P	48	●		108 [4.25]	31.8 [1.25]	81.1 [3.19]	●
	RP-35P	48	●		143 [5.63]	50.8 [2.00]	103.2 [4.06]	●
	RP-40P	48	●		178 [7.01]	[2.25] 57.2	125 [4.92]	●
	RP-43P	48	●		292 [11.50]	74.7 [2.94]	175 [6.89]	●
	RPL/RPLC-1	50	●		44.5 [1.75]	19.1 [0.75]	29.5 [1.16]	●
	RPL/RPLC-2	50	●		59.5 [2.34]	19.1 [0.75]	29.5 [1.16]	●
	RPL/RPLC-3	50	●		80 [3.15]	22.2 [0.87]	32.6 [1.28]	●
	RPL/RPLC-4	50	●		98.1 [3.86]	22.2 [0.87]	32.6 [1.28]	●
General Industrial Grippers								
	CP-1	52	●		37.6 [1.48]	30 [1.18]	39.2 [1.54]	●
	CP-1-C	52	●		42 [1.65]	30 [1.18]	39.2 [1.54]	●
	CP-2	52	●		51.4 [2.02]	40 [1.57]	51.5 [2.03]	●
	CP-2-C	52	●		58.2 [2.29]	40 [1.57]	51.5 [2.03]	●
	CP-3	52	●		70 [2.76]	55 [2.17]	67 [2.64]	●
	CP-3-C	52	●		81.2 [3.20]	55 [2.17]	67 [2.64]	●
	CP-4	52	●		85 [3.35]	65 [2.56]	74 [2.91]	●
	CP-4-C	52	●		96 [3.78]	65 [2.56]	74 [2.91]	●
	CP-5	52	●		102 [4.02]	80 [3.15]	91 [3.58]	●
	CP-5-C	52	●		120 [4.72]	80 [3.15]	91 [3.58]	●
	CP-6	52	●		125 [4.92]	100 [3.94]	114 [4.49]	●
	CP-6-C	52	●		141 [5.55]	100 [3.94]	114 [4.49]	●
	DPDL-047	54	●		54.5 [2.16]	22.2 [0.875]	32.2 [1.27]	●
	DPDL-056	54	●		68.7 [2.70]	24.1 [0.950]	37.7 [1.48]	●
	DPDL-088	54	●		101.1 [3.98]	36.1 [1.420]	56 [2.20]	●
	DPDL-125	54	●		128.4 [5.06]	43.2 [1.700]	68.5 [2.70]	●
	DPDL-175	54	●		183.1 [7.21]	64.8 [2.550]	100.2 [3.94]	●
	DPDL-250	54	●		243.8 [9.58]	79.3 [3.125]	123.3 [4.85]	●
	DPDS-047	56	●		31.2 [1.23]	22.2 [0.87]	25.9 [1.02]	●
	DPDS-056	56	●		39.8 [1.57]	24.1 [0.95]	28.9 [1.14]	●
	DPDS-088	56	●		57.4 [2.26]	36.1 [1.42]	43.4 [1.71]	●
	DPDS-125	56	●		73.5 [2.89]	43.2 [1.70]	52.7 [2.07]	●
	DPDS-175	56	●		114.7 [4.52]	64.8 [2.55]	80.4 [3.17]	●
	DPDS-250	56	●		133.1 [5.24]	79.3 [3.12]	95.5 [3.76]	●
	DPG-10M-1	58	●		62 [2.44]	34.9 [1.37]	44.9 [1.77]	●
	DPG-10M-2	58	●		86 [3.39]	34.9 [1.37]	44.9 [1.77]	●
	DPG-10M-3	58	●		113 [4.45]	34.9 [1.37]	44.9 [1.77]	●
	DPG-10M-4	58	●		137 [5.39]	34.9 [1.37]	44.9 [1.77]	●



CLICK OR SCAN

To view full catalog pages on this product

PARALLEL GRIPPERS

Sizing and Application Chart

Total Gripforce N [lbs]	Maximum Finger Length @ 58psi mm [in]	Actuation Time	Operating Pressure bar [psi]	Environment	Features
0.45-45 [1-10] 45-111 [10-25] 111-223 [25-50] 223-445 [50-100] 445-2225 [100-500] 2225-13350 [500-3000]	0-50.8 [0-2] 50.8-102 [2-4] 102-152 [4-6] 152-203 [6-8] 203-254 [8-10] 254-305 [10-12] 305-356 [12-14] 356-406 [14-16] 406-457 [16-18] 457-508 [18-20] 508+ [20 +]	0.05-0.1 sec. 0.1-0.5 sec. 0.5-0.75 sec. 0.75-1 sec. 5-100 [0.3-7] 20-100 [1.5-7] 29-145 [2-10] 36-145 [2.5-10] 40-100 [3-7] 50-100 [3.5-7] 70-150 [5-7]	Clean Room Environment Normal Environment Harsh/Dirty Environment Failsafe Operation Inductive Sensors Magneto Resistive Sensors Double Acting Cylinder Single Acting/Spring Return Double Acting/Spring Assist Non-Synchronous Option		
Precision Grippers (cont.)					
General Industrial Grippers					





PARALLEL GRIPPERS

Sizing and Application Chart

CLICK OR SCAN

To view full catalog pages on this product

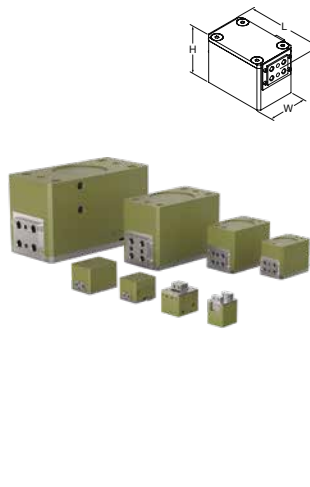

	Series	Page #	Jaws		Basic Unit Dimensions mm [in]			Stroke mm [in]														
			2 Jaws	3 Jaws	Length	Width	Height	0-6.3 [0-0.25]	6.3-12.7 [0.25-0.50]	12.7-19.1 [0.50-0.75]	19.1-25.4 [0.75-1.00]	25.4-31.8 [1.00-1.25]	31.8-38.1 [1.25-1.50]	38.1-44.5 [1.50-1.75]	44.5-50.8 [1.75-2.00]	50.8-57.1 [2.00-2.25]	57.1-63.5 [2.25-2.50]	63.5-69.8 [2.50-2.75]	69.8-76.2 [2.75-3.00]	76.2+ [3.00+]		
General Industrial Grippers (cont.)																						
	RDH-1	60	●		63 [2.48]	33 [1.30]	38.5 [1.52]	●														
	RDH-1-L	60	●		63 [2.48]	33 [1.30]	38.5 [1.52]	●●														
	RDH-2	60	●		83 [3.27]	40 [1.57]	58 [2.28]	●														
	RDH-2-L	60	●		83 [3.27]	40 [1.57]	58 [2.28]	●●														
	RDH-3	60	●		104 [4.09]	50 [1.97]	66 [2.60]	●●														
	RDH-3-L	60	●		104 [4.09]	50 [1.97]	66 [2.60]	●●●														
	RDH-4	60	●		129 [5.08]	60 [2.36]	74.5 [2.93]	●●														
	RDH-4-L	60	●		129 [5.08]	60 [2.36]	74.5 [2.93]	●●●●														
	RDH-5	60	●		162 [6.38]	76 [2.99]	90.5 [3.56]	●●●														
	RDH-5-L	60	●		162 [6.38]	76 [2.99]	90.5 [3.56]	●●●●														
	RDH-6	60	●		205 [8.07]	100 [3.94]	113 [4.45]	●●●														
	RDH-6-L	60	●		205 [8.07]	100 [3.94]	113 [4.45]	●●●●														
	RDH-7	60	●		258 [10.16]	120 [4.72]	147 [5.79]	●●●														
	RDH-7-L	60	●		258 [10.16]	120 [4.72]	147 [5.79]	●●●●														
	RDH-8	60	●		355 [13.98]	180 [7.09]	201 [7.91]	●●●●														
RDH-8-L	60	●		355 [13.98]	180 [7.09]	201 [7.91]	●●●●●															
	REP-62	62	●		70 [2.76]	60 [2.36]	72 [2.83]	●●														
	REP-62-C	62	●		82 [3.23]	60 [2.36]	72 [2.83]	●●●														
	REP-82	62	●		94 [3.70]	80 [3.15]	74 [2.91]	●●														
	REP-82-C	62	●		108 [4.25]	80 [3.15]	74 [2.91]	●●●														
	REP-112	62	●		138 [5.43]	110 [4.33]	98 [3.86]	●●●														
	REP-112-C	62	●		158 [6.22]	110 [4.33]	98 [3.86]	●●●●														
	RP-5	64	●		29 [1.14]	25.4 [1.00]	36.5 [1.44]	●														
	RP-10	64	●		38.1 [1.50]	31.7 [1.25]	37.3 [1.47]	●														
	RP-11	66	●		48 [1.89]	31.8 [1.25]	28.6 [1.13]	●														
	RP-11-D	66	●		45 [1.77]	31.8 [1.25]	28.6 [1.13]	●														
	RP-12	66	●		63 [2.48]	31.8 [1.25]	35.6 [1.40]	●●														
	RP-12-D	66	●		60 [2.36]	31.8 [1.25]	35.6 [1.40]	●														
	RP-15	66	●		81 [3.19]	41.3 [1.63]	47.3 [1.86]	●●														
	RP-15-D	66	●		76 [2.99]	41.3 [1.63]	47.3 [1.86]	●●														
	RP-17	66	●		108 [4.25]	54 [2.13]	61.9 [2.44]	●●●														
	RP-17-D	66	●		117 [4.61]	54 [2.13]	61.9 [2.44]	●●●●														
	RP-18	66	●		177 [6.97]	74.9 [2.95]	92.8 [3.65]	●●●●														
RP-18-D	66	●		190 [7.48]	74.9 [2.95]	92.8 [3.65]	●●●●●															
RP-19	66	●		266 [10.47]	100.3 [3.95]	118.7 [4.67]	●●●●●															
RP-19-D	66	●		254 [10.00]	100.3 [3.95]	118.7 [4.67]	●●●●●															
	RPM/RPMC-1	68	●		23 [0.91]	16 [0.63]	24 [0.94]	●														
	RPM/RPMC-2	68	●		24 [0.94]	16 [0.63]	25.5 [1.00]	●														
	RPM/RPMC-3	68	●		30 [1.18]	16 [0.63]	25.5 [1.00]	●														

PARALLEL GRIPPERS

Sizing and Application Chart

CLICK OR SCAN

To view full
catalog pages
on this product



	Series	Page #	Jaws		Basic Unit Dimensions mm [in]			Stroke mm [in]											
			2 Jaws	3 Jaws	Length	Width	Height	0-6.3 [0-0.25]	6.3-12.7 [0.25-0.50]	12.7-19.1 [0.50-0.75]	19.1-25.4 [0.75-1.00]	25.4-31.8 [1.00-1.25]	31.8-38.1 [1.25-1.50]	38.1-44.5 [1.50-1.75]	44.5-50.8 [1.75-2.00]	50.8-57.1 [2.00-2.25]	57.1-63.5 [2.25-2.50]	63.5-69.8 [2.50-2.75]	69.8-76.2 [2.75-3.00]
General Industrial Grippers (cont.)																			
	RPS-11	70	●		48 [1.88]	31.8 [1.25]	44.1 [1.74]	●											
	RPS-11-D	70	●		45 [1.79]	31.8 [1.25]	44.1 [1.74]	●											
	RPS-12	70	●		63 [2.50]	31.8 [1.25]	51.2 [2.02]	●	●										
	RPS-12-D	70	●		60 [2.37]	31.8 [1.25]	51.2 [2.02]	●											
	RPS-15	70	●		81 [3.19]	41.3 [1.63]	71.6 [2.82]	●	●										
	RPS-15-D	70	●		76 [3.00]	41.3 [1.63]	71.6 [2.82]	●	●										
	RPS-17	70	●		107 [4.25]	54.0 [2.13]	98.7 [3.89]	●	●										
	RPS-17-D	70	●		117 [4.60]	54.0 [2.13]	98.7 [3.89]	●	●	●									
	RPS-18	70	●		177 [7.00]	74.9 [2.95]	154.4 [6.08]	●	●	●									
RPS-18-D	70	●		190 [7.45]	74.9 [2.95]	154.4 [6.08]	●	●	●										
Heavy-Duty Grippers																			
	DPW-250-1	72	●		98 [3.86]	37.6 [1.48]	37.6 [1.48]	●	●										
	DPW-250-2	72	●		136 [5.35]	37.6 [1.48]	37.6 [1.48]	●	●	●									
	DPW-375-1	72	●		122 [4.80]	54 [2.13]	54 [2.13]	●	●										
	DPW-375-2	72	●		198 [7.80]	54 [2.13]	54 [2.13]	●	●	●									
	DPW-500-1	72	●		164 [6.46]	63 [2.48]	63 [2.48]	●	●	●									
	DPW-500-2	72	●		240 [9.45]	63 [2.48]	63 [2.48]	●	●	●	●								
	RPB-24	74	●		438.2 [17.25]	88.9 [3.50]	129 [5.08]	●	●	●	●	●	●	●	●	●	●	●	
	RPB-26	74	●		590.5 [23.25]	88.9 [3.50]	129 [5.08]	●	●	●	●	●	●	●	●	●	●	●	
	RPB-28	74	●		734 [28.90]	88.9 [3.50]	129 [5.08]	●	●	●	●	●	●	●	●	●	●	●	
	RPR-63M-150	76	●		489.8 [19.28]	88.9 [3.50]	161.9 [6.37]	●	●	●	●	●	●	●	●	●	●	●	
	RPR-63M-200	76	●		539.8 [21.25]	88.9 [3.50]	161.9 [6.37]	●	●	●	●	●	●	●	●	●	●	●	
	RPR-63M-250	76	●		589.8 [23.22]	88.9 [3.50]	161.9 [6.37]	●	●	●	●	●	●	●	●	●	●	●	
	RPR-63M-300	76	●		639.8 [25.19]	88.9 [3.50]	161.9 [6.37]	●	●	●	●	●	●	●	●	●	●	●	
	RPR-63M-350	76	●		689.8 [27.16]	88.9 [3.50]	161.9 [6.37]	●	●	●	●	●	●	●	●	●	●	●	
	RPW-250	78	●		93 [3.66]	31.5 [1.24]	40.9 [1.61]	●	●										
	RPW-375-1	78	●		120 [4.72]	37.8 [1.49]	50.5 [1.99]	●	●										
	RPW-375-2	78	●		187 [7.36]	37.8 [1.49]	50.5 [1.99]	●	●	●									
	RPW-500-1	78	●		171 [6.73]	56.9 [2.24]	66.4 [2.61]	●	●	●									
	RPW-500-2	78	●		234 [9.21]	56.9 [2.24]	66.4 [2.61]	●	●	●	●								
	RPW-625-1	78	●		219 [8.62]	66.4 [2.61]	82.3 [3.24]	●	●	●	●								
	RPW-625-2	78	●		321 [12.64]	66.4 [2.61]	82.3 [3.24]	●	●	●	●	●							
	RPW-750	78	●		410 [16.14]	75 [2.95]	99.8 [3.93]	●	●	●	●	●	●	●	●	●	●	●	
OEM Grippers																			
	G110-08M	80	●		[1.69-4.06] 43-103	20 [0.79]	28 [1.10]	●	●										
	G110-11M	80	●		[1.69-4.06] 43-103	24 [0.94]	36.5 [1.44]	●	●										
	G110-18M	80	●		[2.13-4.92] 54-125	30 [1.18]	43 [1.69]	●	●										
	G110-25M	80	●		[2.87-7.60] 73-193	40 [1.57]	61 [2.40]	●	●										



CLICK OR SCAN

To view full catalog pages on this product

PARALLEL GRIPPERS

Sizing and Application Chart

Total Gripforce N [lbs]		Maximum Finger Length @ 60psi mm [in]		Actuation Time		Operating Pressure bar [psi]		Environment		Features																									
0-45 [1-10]	45-111 [10-25]	111-223 [25-50]	223-445 [50-100]	445-2225 [100-500]	2225-13350 [500-3000]	0-50.8 [0-2]	50.8-102 [2-4]	102-152 [4-6]	152-203 [6-8]	203-254 [8-10]	254-305 [10-12]	305-356 [12-14]	356-406 [14-16]	406-457 [16-18]	457-508 [18-20]	508+ [20+]	0.05-0.1 sec.	0.1-0.5 sec.	0.5-0.75 sec.	0.75-1 sec.	5-100 [0.3-7]	20-100 [1.5-7]	40-100 [3-7]	50-100 [3.5-7]	70-150 [5-7]	Clean Room Environment	Normal Environment	Harsh/Dirty Environment	Failsafe Operation	Inductive Sensors	Magneto Resistive Sensors	Double Acting Cylinder	Single Acting/Spring Return	Double Acting/Spring Assist	Non-Synchronous Option
													General Industrial Grippers (cont.)																						
													Heavy-Duty Grippers																						
													OEM Grippers																						

PARALLEL GRIPPERS

Sizing and Application Chart

CLICK OR SCAN

To view full
catalog pages
on this product



	Series	Page #	Jaws		Basic Unit Dimensions mm [in]		Stroke mm [in]												
			2 Jaws	3 Jaws	Diameter	Height	0-6.3 [0-0.25]	6.3-12.7 [0.25-0.50]	12.7-19.1 [0.50-0.75]	19.1-25.4 [0.75-1.00]	25.4-31.8 [1.00-1.25]	31.8-38.1 [1.25-1.50]	38.1-44.5 [1.50-1.75]	44.5-50.8 [1.75-2.00]	50.8-57.1 [2.00-2.25]	57.1-63.5 [2.25-2.50]	63.5-69.8 [2.50-2.75]	69.8-76.2 [2.75-3.00]	76.2+ [3.00+]
	6003P	84	●		72 [2.83]	77 [3.03]	●●												
	6003P-C	84	●		78 [3.07]	77 [3.03]	●●●												
	8003P	84	●		91.6 [3.61]	78 [3.07]	●●●												
	8003P-C	84	●		98.4 [3.87]	78 [3.07]	●●●●												
	11003P	84	●		126 [4.96]	106 [4.17]	●●●●●												
	11003P-C	84	●		136 [5.35]	106 [4.17]	●●●●●●												
	14003P	84	●		165 [6.50]	137 [5.39]	●●●●●●●												
	14003P-C	84	●		179 [7.05]	137 [5.39]	●●●●●●●●												
	16503P	84	●		194 [7.64]	169 [6.65]	●●●●●●●●												
	16503P-C	84	●		204 [8.03]	169 [6.65]	●●●●●●●●●												
	RTH-1M	86	●		63 [2.48]	43 [1.69]	●												
	RTH-1M-L	86	●		63 [2.48]	43 [1.69]	●●												
	RTH-2M	86	●		83 [3.27]	57 [2.24]	●												
	RTH-2M-L	86	●		83 [3.27]	57 [2.24]	●●												
	RTH-3M	86	●		83 [3.27]	57 [2.24]	●●												
	RTH-3M-L	86	●		83 [3.27]	57 [2.24]	●●●												
	RTH-4M	86	●		129 [5.08]	84.5 [3.48]	●●												
	RTH-4M-L	86	●		129 [5.08]	84.5 [3.48]	●●●●												
	RTH-5M	86	●		162 [6.38]	98.5 [3.84]	●●												
	RTH-5M-L	86	●		162 [6.38]	98.5 [3.84]	●●●●												
	RTH-6M	86	●		205 [8.07]	121 [4.76]	●●												
	RTH-6M-L	86	●		205 [8.07]	121 [4.76]	●●●●												
RTH-7M	86	●		258 [10.16]	155 [6.10]	●●													
RTH-7M-L	86	●		258 [10.16]	155 [6.10]	●●●●													
RTH-8M	86	●		355 [13.98]	209 [8.23]	●●													
RTH-8M-L	86	●		355 [13.98]	209 [8.23]	●●●●													
	PPC-12	88	●		43 [1.69]	74 [2.91]	●●												
	PPC-12-C	88	●		49.03 [1.93]	78 [3.07]	●●●												
	PPC-25	88	●		61.5 [2.42]	87 [3.43]	●●												
	PPC-25-C	88	●		68.5 [2.70]	92 [3.62]	●●●												
	PPC-34	88	●		82.5 [3.25]	112 [4.41]	●●												
	PPC-34-C	88	●		92.5 [3.64]	117 [4.61]	●●●												
	REP-63	90	●		72 [2.83]	77 [3.03]	●●												
	REP-63-C	90	●		78 [3.07]	77 [3.03]	●●●												
	REP-83	90	●		91.6 [3.61]	78 [3.07]	●●												
	REP-83-C	90	●		98.4 [3.87]	78 [3.07]	●●●												
	REP-113	90	●		126 [4.96]	103 [4.06]	●●												
	REP-113-C	90	●		136 [5.35]	103 [4.06]	●●●												
	RPC-315	92	●		62 [2.44]	41 [1.61]	●●												
	RPC-320	92	●		82 [3.23]	50 [1.97]	●●												
	RPC-331	92	●		118 [4.65]	75.1 [2.96]	●●												
	RPC-344	92	●		140 [5.51]	82.2 [3.24]	●●												
	RPC-356	92	●		180 [7.24]	101.1 [3.98]	●●												
	RPC-368	92	●		206 [8.11]	118 [4.65]	●●												



CLICK OR SCAN

To view full catalog pages on this product

PARALLEL GRIPPERS

Sizing and Application Chart

Total Gripforce N [lbs]	Maximum Finger Length @ 60psi mm [in]	Actuation Time	Operating Pressure bar [psi]	Environment	Features
0.45-45 [1-10] 45-111 [10-25] 111-223 [25-50] 223-445 [50-100] 445-2225 [100-500] 2225-13350 [500-3000]	0-50.8 [0-2] 50.8-102 [2-4] 102-152 [4-6] 152-203 [6-8] 203-254 [8-10] 254-305 [10-12] 305-356 [12-14] 356-406 [14-16] 406-457 [16-18] 457-508 [18-20] 508+ [20 +]	0.05-0.1 sec. 0.1-0.5 sec. 0.5-0.75 sec. 0.75-1 sec.	5-100 [0.3-7] 20-100 [1.5-7] 30-100 [2-7] 40-100 [3-7] 45-100 [3.1-7] 50-100 [3.5-7] 55-100 [3.8-7] 60-100 [4-7] 70-150 [5-7]	Clean Room Environment Normal Environment Harsh/Dirty Environment	Fail-safe Operation Inductive Sensors Magneto Resistive Sensors Double Acting Cylinder Single Acting/Spring Return Double Acting/Spring Assist Non-Synchronous Option
Three Jaw Grippers					

ANGULAR GRIPPERS

Sizing and Application Chart

CLICK OR SCAN

To view full
catalog pages
on this product



Series	Page #	Jaws		Basic Unit Dimensions mm [in]			Angle (Both Jaws)				Total Gripforce N [lbs]					
		2 Jaws	3 Jaws	Length	Width	Height	12 Degrees	30 Degrees	70 Degrees	180 Degrees	0.45-45 [1-10]	45-111 [10-25]	111-223 [25-50]	223-445 [50-100]	445-2225 [100-500]	2225-13350 [500-3000]
Angular Grippers													GR-ANG-#			
	CT-12M	94	●	30 [1.18]	20 [0.79]	48 [1.89]				●	●					
	CT-12M-RE	94	●	30 [1.18]	20 [0.79]	64 [2.52]				●	●					
	CT-16M	94	●	36 [1.42]	25 [0.98]	64 [2.52]				●	●	●				
	CT-16M-RE	94	●	36 [1.42]	25 [0.98]	71 [2.80]				●	●	●				
	CT-20M	94	●	42 [1.65]	30 [1.18]	79 [3.11]				●	●	●				
	CT-20M-RE	94	●	42 [1.65]	30 [1.18]	83 [3.27]				●	●	●	●			
	CT-25M	94	●	50 [1.97]	36 [1.42]	93.5 [3.68]				●	●	●	●			
	CT-25M-RE	94	●	50 [1.97]	36 [1.42]	102 [4.02]				●	●	●	●	●		
	CT-32M	94	●	56 [2.20]	42 [1.65]	95 [3.74]				●	●	●	●	●		
	CT-32M-RE	94	●	56 [2.20]	42 [1.65]	116 [4.57]				●	●	●	●	●		
	CT-40M	94	●	66 [2.60]	52 [2.05]	107.5 [4.23]				●	●	●	●	●		
	CT-40M-RE	94	●	66 [2.60]	52 [2.05]	135 [5.31]				●	●	●	●	●		
	CT-50M	94	●	76 [2.99]	62 [2.44]	146 [5.75]				●	●	●	●	●		
CT-50M-RE	94	●	76 [2.99]	62 [2.44]	163 [6.42]				●	●	●	●	●			
	RA-5	96	●	25.4 [1.00]	38.1 [1.50]	35.0 [1.38]				●	●					
	RA-6	96	●	38.1 [1.50]	50.8 [2.00]	49.6 [1.95]				●	●					
	RA-7	96	●	50.8 [2.00]	76.2 [3.00]	60.8 [2.39]				●	●					
	RA-8	96	●	76.2 [3.00]	101.6 [4.00]	76.2 [3.00]				●	●					
	RA-10	96	●	25.4 [1.00]	25.4 [1.00]	20.7 [0.81]				●	●					
	RA-15	98	●	25.4 [1.00]	44.5 [1.75]	38.9 [1.53]	●				●	●				
	RA-25	98	●	44.5 [1.75]	63.5 [2.50]	61.9 [2.44]	●				●	●				
	RA-90	98	●	39 [1.54]	28 [1.10]	67.3 [2.65]				●	●					
	RUA-62M	100	●		∅60 [∅2.36]	53 [2.09]				●	●					
	RUA-82M	100	●		∅80 [∅3.15]	57 [2.24]				●	●					
	RUA-112M	100	●		∅110 [∅4.33]	175 [6.89]				●	●					
	RUA-142M	100	●		∅140 [∅5.51]	107 [4.21]				●	●					
	RUA-162M	100	●		∅165 [∅6.50]	119 [4.69]				●	●					
GR-SPC-#																
	FUA-50M	102	●	85 [3.35]	75 [2.95]	52 [2.05]				●				See Datasheet		
	FUA-63M	102	●	100 [3.90]	90 [3.54]	62 [2.44]				●				See Datasheet		



CLICK OR SCAN

To view full catalog pages on this product

ANGULAR GRIPPERS

Sizing and Application Chart

Maximum Finger Length @ 60psi mm [in]		Actuation Time				Operating Pressure bar [psi]		Environment			Features			
											Angular Grippers			
0-50.8 [0-2]														
50.8-102 [2-4]														
102-152 [4-6]														
152-203 [6-8]														
203-254 [8-10]														
254-305 [10-12]														
305-356 [12-14]														
356-406 [14-16]														
406-457 [16-18]														
457-508 [18-20]														
508+ [20 +]														
0.05-0.1 sec.														
0.1-0.5 sec.														
0.5-0.75 sec.														
0.75-1 sec.														
5-100 [0.3-7]														
20-100 [1.5-7]														
30-100 [2-7]														
45-100 [3.1-7]														
40-100 [3-7]														
50-100 [3.5-7]														
60-100 [4-7]														
Clean Room Environment														
Normal Environment														
Harsh/Dirty Environment														
Failsafe Operation														
Inductive Sensors														
Magneto Resistive Sensors														
Double Acting Cylinder														
Single Acting/Spring Return														
Double Acting/Spring Assist														
Non-Synchronous Option														

ROTARY ACTUATORS

Sizing and Application Chart

CLICK OR SCAN

To view full
catalog pages
on this product



	Series	Page #	Ports/ Mounting		Rotary Type		Basic Unit Dimensions mm [in]			Maximum Torque Nm [in-lb]						
			Imperial	Metric	Flange Output	Shaft Output	Length	Width	Height	0-111 [0-25]	111-223 [25-50]	223-445 [50-100]	445-678 [100-150]	678-890 [150-200]	890-1335 [200-300]	1335+ [300+]
RR-Light Duty		GR-ROT-#														
	RR-18/-18M	104	●	●	●		61 [2.42]	57.1 [2.25]	24.6 [.969]	●						
	RR-28/-28M	104	●	●	●		83.1 [3.28]	85.7 [3.375]	33.1 [1.313]	●						
RR-Medium Duty		GR-ROT-#														
	RR-36/-36M	106	●	●	●		170.9 [6.73]	101.6 [4.00]	43.7 [1.72]	●						
	RR-46/-46M	106	●	●	●		203.2 [8.00]	113.5 [4.47]	54.1 [2.13]	●—●						
RR-Heavy Duty		GR-ROT-#														
	RR-56M	108	●	●	●		[8.50] 215.9	117.5 [4.63]	70.2 [2.77]	●—●						
	RR-66M	108	●	●	●		[10.35] 262.8	158.8 [6.25]	96.8 [3.81]	●—●—●						



CLICK OR SCAN

To view full catalog pages on this product

ROTARY ACTUATORS

Sizing and Application Chart

Degrees of Rotation	Maximum Payload Kg [lbs]	Maximum Inertia Nm sec ² x 10 ³ [in-lbs sec ²]	Actuation Time 180°	Operating Pressure bar [psi]	Features
45°	0-10 [0-5]	0.0-0.1 [0.000-0.001]	0.05-0.1 sec.	2-7 [20-100]	
90°	10-25 [5-11]	0.1-0.6 [0.001-0.005]	0.1-0.5 sec.	3-7 [40-100]	
135°	25-50 [11-23]	0.6-1.1 [0.005-0.010]	0.5-0.75 sec.	Inductive Sensors	
180°	50-100 [23-45]	1.1-2.8 [0.010-0.025]	0.75+ sec.	Magneto Resistive Sensors	
0-10 [0-5]	100-150 [45-68]	2.8-5.7 [0.025-0.050]		Shock Absorbers	
10-25 [5-11]	150+ [68+]	5.7-11.3 [0.050-0.100]		Mid-Stop	
25-50 [11-23]		11.3-56.5 [0.100-0.500]		Air Manifold	
50-100 [23-45]		56.5-282.5 [0.500-2.500]		High Temperature	
100-150 [45-68]		282.5-565 [2.500-5.000]			
150+ [68+]					
0.0-0.1 [0.000-0.001]					
0.1-0.6 [0.001-0.005]					
0.6-1.1 [0.005-0.010]					
1.1-2.8 [0.010-0.025]					
2.8-5.7 [0.025-0.050]					
5.7-11.3 [0.050-0.100]					
11.3-56.5 [0.100-0.500]					
56.5-282.5 [0.500-2.500]					
282.5-565 [2.500-5.000]					
0.05-0.1 sec.					
0.1-0.5 sec.					
0.5-0.75 sec.					
0.75+ sec.					
2-7 [20-100]					
3-7 [40-100]					
Inductive Sensors					
Magneto Resistive Sensors					
Shock Absorbers					
Mid-Stop					
Air Manifold					
High Temperature					
RR-Light Duty					
●	●	●	●	●	●
●	●	●	●	●	●
RR-Medium Duty					
●	●	●	●	●	●
●	●	●	●	●	●
RR-Heavy Duty					
●	●	●	●	●	●
●	●	●	●	●	●

LINEAR SLIDES

Sizing and Application Chart

CLICK OR SCAN

To view full
catalog pages
on this product



Series	Page #	Slide Type			Basic Unit Dimensions mm [in]			Maximum Thrust Force N [lbs]					
		Base Slide	Thru-ster Slide	Lift/Block Thru-ster	Length + Stroke	Width	Height	0-111 [0-25]	111-223 [25-50]	223-445 [50-100]	445-678 [100-150]	678-890 [150-200]	890-1335 [200-300]
Base Slide—Internal Air Cylinder													
	DLB-06M-B	110	●		81 [3.19]	50.3 [1.98]	23.7 [0.93]	●					
	DLB-08M-B	110	●		93.7 [3.69]	62.7 [2.47]	23.7 [0.93]	●					
	DLB-10M-B	110	●		143 [5.63]	88.6 [3.49]	31.6 [1.24]	●	●				
	DLB-12M-B	110	●		155.7 [6.13]	101.2 [3.98]	42.1 [1.66]	●	●	●			
	DLB-16M-B	110	●		174.8 [6.88]	120.3 [4.74]	42.1 [1.66]	●	●	●			
	DLB-20M-B	110	●		239.3 [9.42]	164.6 [6.48]	55.4 [2.18]	●	●	●	●		
	DLB-25M-B	110	●		275.3 [10.84]	190 [7.48]	55.4 [2.18]	●	●	●	●	●	
Base Slide—Internal Air Cylinder—Long Stroke													
	DLB-06M-L	110	●		125.5 [4.94]	50.3 [1.98]	23.7 [0.93]	●					
	DLB-08M-L	110	●		138.2 [5.44]	62.7 [2.47]	23.7 [0.93]	●					
	DLB-10M-L	110	●		193.8 [7.63]	88.6 [3.49]	31.6 [1.24]	●	●				
	DLB-12M-L	110	●		219.2 [8.63]	101.2 [3.98]	42.1 [1.66]	●	●	●			
	DLB-16M-L	110	●		244.6 [9.63]	120.3 [4.74]	42.1 [1.66]	●	●	●			
	DLB-20M-L	110	●		290.1 [11.42]	164.6 [6.48]	55.4 [2.18]	●	●	●	●		
	DLB-25M-L	110	●		326.1 [12.84]	190 [7.48]	55.4 [2.18]	●	●	●	●	●	
Linear Thru-ster Slide—External Air Cylinder													
	DLB-06-T	113	●		129.4 [5.09]	50.3 [1.98]	23.7 [0.93]	●					
	DLB-08-T	113	●		142.1 [5.59]	62.7 [2.47]	23.7 [0.93]	●					
	DLB-10-T, A	113	●		237.4 [9.35]	88.6 [3.49]	31.6 [1.24]	●	●				
	DLB-12-T, A	113	●		253.6 [9.98]	101.2 [3.98]	42.1 [1.66]	●	●	●			
	DLB-16-T, A	113	●		272.6 [10.73]	120.3 [4.74]	42.1 [1.66]	●	●	●			
	DLB-10-N	113	●		236.8 [9.07]	88.6 [3.49]	31.6 [1.24]	●	●				
	DLB-12-N	113	●		249.5 [9.57]	101.2 [3.98]	42.1 [1.66]	●	●	●			
	DLB-16-N	113	●		268.5 [10.32]	120.3 [4.74]	42.1 [1.66]	●	●	●			
	DLB-20-T, A	113	●		315.5 [12.42]	164.6 [6.48]	56.8 [2.24]	●	●	●	●		
	DLB-25-T, A	113	●		351.5 [13.84]	190 [7.48]	56.8 [2.24]	●	●	●	●		
	DLB-20-N	113	●		337.3 [13.28]	164.6 [6.48]	56.8 [2.24]	●	●	●	●		
	DLB-25-N	113	●		373.3 [14.70]	190 [7.48]	56.8 [2.24]	●	●	●	●	●	

LINEAR SLIDES

Sizing and Application Chart

CLICK OR SCAN

To view full
catalog pages
on this product



Series	Page #	Slide Type			Basic Unit Dimensions mm [in]			Maximum Thrust Force N [lbs]					
		Base Slide	Thrust Slide	Lift/Block Thruster	Length + Stroke	Width	Height	0-111 [0-25]	111-223 [25-50]	223-445 [50-100]	445-678 [100-150]	678-890 [150-200]	890-1335 [200-300]
Linear Thruster Slide—Internal Air Cylinder—Block Style													
	DLT-06M-B	116	●	●	70.7 [2.78]	50.8 [2.00]	22.4 [0.88]	●					
	DLT-08M-B	116	●	●	83.4 [3.28]	63.5 [2.50]	22.4 [0.88]	●					
	DLT-10M-B	116	●	●	122.3 [4.81]	88.9 [3.50]	30.2 [1.19]	●	●				
	DLT-12M-B	116	●	●	135 [5.31]	101.6 [4.00]	41.4 [1.63]	●	●	●			
	DLT-16M-B	116	●	●	155.6 [6.13]	120.7 [4.75]	41.4 [1.63]	●	●	●			
	DLT-20M-B	116	●	●	214.9 [8.46]	165.1 [6.50]	55.9 [2.20]	●	●	●	●		
	DLT-25M-B	116	●	●	245.6 [9.67]	190.5 [7.50]	55.9 [2.20]	●	●	●	●		
Linear Thruster Slide—Internal Air Cylinder—Extended Stroke													
	DLT-06M-E	116	●		87.5 [3.44]	50.8 [2.00]	22.4 [0.88]	●					
	DLT-08M-E	116	●		93.8 [3.69]	63.5 [2.50]	22.4 [0.88]	●					
	DLT-10M-E	116	●		143.1 [5.63]	88.9 [3.50]	30.2 [1.19]	●	●				
	DLT-12M-E	116	●		155.8 [6.13]	101.6 [4.00]	41.4 [1.63]	●	●	●			
	DLT-16M-E	116	●		174.9 [6.89]	120.7 [4.75]	41.4 [1.63]	●	●	●			
	DLT-20M-E	116	●		239.3 [9.42]	165.1 [6.50]	55.9 [2.20]	●	●	●	●		
	DLT-25M-E	116	●		275.3 [10.84]	190.5 [7.50]	55.9 [2.20]	●	●	●	●		
Linear Thruster Slide—Internal Air Cylinder—Long Body													
	DLT-06M-L	116	●		115.1 [4.53]	50.8 [2.00]	22.4 [0.88]	●					
	DLT-08M-L	116	●		127.8 [5.03]	63.5 [2.50]	22.4 [0.88]	●					
	DLT-10M-L	116	●		173.1 [6.81]	88.9 [3.50]	30.2 [1.19]	●	●				
	DLT-12M-L	116	●		198.5 [7.81]	101.6 [4.00]	41.4 [1.63]	●	●	●			
	DLT-16M-L	116	●		225.5 [8.88]	120.7 [4.75]	41.4 [1.63]	●	●	●			
	DLT-20M-L	116	●		271.8 [10.70]	165.1 [6.50]	55.9 [2.20]	●	●	●	●		
	DLT-25M-L	116	●		297.2 [11.70]	190.5 [7.50]	55.9 [2.20]	●	●	●	●		
Linear Thruster Slide—External Air Cylinder													
	DLT-06-T	119	●		125.6 [4.94]	50.8 [2.00]	22.4 [0.88]	●					
	DLT-08-T	119	●		138.3 [5.44]	63.5 [2.50]	22.4 [0.88]	●					
	DLT-10-T, A	119	●		210.3 [8.28]	88.9 [3.50]	30.2 [1.19]	●	●				
	DLT-12-T, A	119	●		226.5 [8.92]	101.6 [4.00]	41.4 [1.63]	●	●	●			
	DLT-16-T, A	119	●		247.1 [9.73]	120.7 [4.75]	41.4 [1.63]	●	●	●			
	DLT-10-N	119	●		209.7 [8.25]	88.9 [3.50]	30.2 [1.19]	●	●				
	DLT-12-N	119	●		222.4 [8.75]	101.6 [4.00]	41.4 [1.63]	●	●	●			
	DLT-16-N	119	●		243.0 [9.57]	120.7 [4.75]	41.4 [1.63]	●	●	●			
	DLT-20-T, A	119	●		322.6 [12.70]	165.1 [6.50]	55.9 [2.20]	●	●	●	●		
	DLT-25-T, A	119	●		353.3 [13.91]	190.5 [7.50]	55.9 [2.20]	●	●	●	●		
	DLT-20-N	119	●		322.6 [12.70]	165.1 [6.50]	55.9 [2.20]	●	●	●	●		
	DLT-25-N	119	●		353.3 [13.91]	190.5 [7.50]	55.9 [2.20]	●	●	●	●		

LINEAR SLIDES

Sizing and Application Chart

CLICK OR SCAN

To view full catalog pages on this product



	Series	Page #	Slide Type			Basic Unit Dimensions mm [in]			Maximum Thrust Force N [lbs]									
			Base Slide	Thrustor Slide	Lift/Block Thruster	Length	Width	Height	0-111 [0-25]	111-223 [25-50]	223-445 [50-100]	445-678 [100-150]	678-890 [150-200]	890-1335 [200-300]	1335+ [300+]			
Miniature Rail Thruster Slide																		
	DLM-07M-12	122	●			78 [3.07]	21 [0.83]	35.5 [1.40]	●									
	DLM-07M-25	122	●			102 [4.02]	21 [0.83]	35.5 [1.40]	●									
	DLM-07M-38	122	●			115 [4.53]	21 [0.83]	35.5 [1.40]	●									
	DLM-07M-50	122	●			127 [5.00]	21 [0.83]	35.5 [1.40]	●									
	DLM-09M-25	122	●			113 [4.45]	32 [1.26]	62 [2.44]	●	●								
	DLM-09M-50	122	●			159 [6.26]	32 [1.26]	62 [2.44]	●	●								
	DLM-09M-75	122	●			184 [7.24]	32 [1.26]	62 [2.44]	●	●								
	DLM-09M-100	122	●			209 [8.23]	32 [1.26]	62 [2.44]	●	●								
	DLM-12M-50	122	●			122 [4.96]	32 [1.26]	65 [2.56]	●	●	●							
	DLM-12M-75	122	●			166 [6.54]	32 [1.26]	65 [2.56]	●	●	●							
DLM-12M-50	122	●			193 [7.60]	32 [1.26]	65 [2.56]	●	●	●								
DLM-12M-100	122	●			218 [8.58]	32 [1.26]	65 [2.56]	●	●	●								
	MPS-1M-1	124	●			46 [1.81]	20.6 [0.81]	31.8 [1.25]	●									
	MPS-1M-2	124	●			63.4 [2.50]	20.6 [0.81]	31.8 [1.25]	●									
	MPS-1M-3	124	●			88.9 [3.50]	20.6 [0.81]	31.8 [1.25]	●									
	MPS-1M-4	124	●			113 [4.45]	20.6 [0.81]	31.8 [1.25]	●									
	MPS-2M-1	124	●			46 [1.81]	27 [1.06]	39.7 [1.56]	●	●								
	MPS-2M-2	124	●			64.4 [2.54]	27 [1.06]	39.7 [1.56]	●	●								
	MPS-2M-3	124	●			88.9 [3.50]	27 [1.06]	39.7 [1.56]	●	●								
	MPS-2M-4	124	●			113 [4.45]	27 [1.06]	39.7 [1.56]	●	●								

FEED ESCAPEMENTS

CLICK OR SCAN

To view full catalog pages on this product



	Series	Page #	Shaft		Basic Unit Dimensions mm [in]			Max. Thrust Force N [lbs]	Maximum Stroke mm [in]	Operating Pressure bar [psi]	Cylinder Type	Features					
			Dual Shaft	Single Shaft	Length	Width	Height					0-111 [0-25]	111-223 [25-50]	223-445 [50-100]	12.7-19.1 [0.50-0.75]	19.1-25.4 [0.75-1.00]	25.4-31.8 [1.00-1.25]
Feed Escapements																	
	RFE-1	126	●		117 [4.59]	38.1 [1.50]	19.1 [0.75]	●		●	●	●	✓	✓	✓	✓	✓
	RFE-2	126	●		162 [6.39]	57.2 [2.25]	24.9 [0.98]		●		●	●	●	✓	✓	✓	✓
	RFE-3	126	●		197 [7.74]	69.9 [2.75]	34.5 [1.36]			●	●	●	●	✓	✓	✓	✓
	RN-1	128	●		116 [4.59]	22.2 [0.88]	19.1 [0.75]	●		●	●	●	✓	✓	✓	✓	✓
	RN-2	128	●		161 [6.34]	28.6 [1.13]	24.9 [0.98]		●		●	●	●	✓	✓	✓	✓
	RN-2	128	●		195 [7.70]	34.9 [1.38]	34.5 [1.36]			●	●	●	●	✓	✓	✓	✓

DPE-400 HEAVY-DUTY

Electric Parallel Grippers

CLICK OR SCAN

To view full catalog pages on this product



How To Order

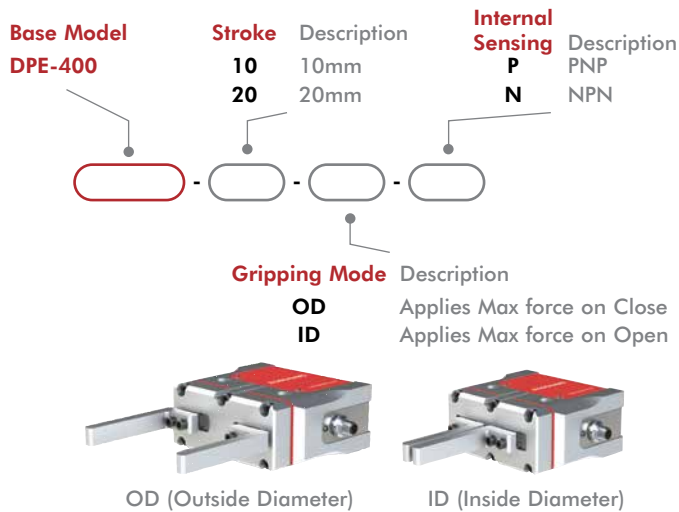

Shown with customer supplied fingers.

Basic Unit Dimensions

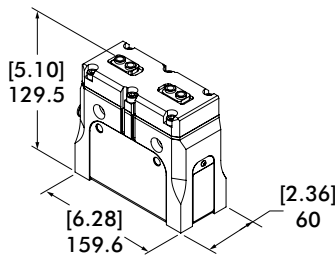

Accessories

Power and Sensor Accessories	Part Number
PNP Magneto-Resistive Position Sensor	OHSP-017
NPN Magneto-Resistive Position Sensor	OHSN-017
Quick Disconnect Sensor Cable, 5m long	CABL-013
8-wire Power and Signal Cable, 5m long w/Straight M12 Connector	CABL-052
8-wire Power and Signal Cable, 5m long w/90° M12 Connector	CABL-053

*Sensor and cable sold separately.

Specifications	Units	DPE-400
Total Rated Grip Force:		
DPE-400-10	N [lbf]	667-1334 [150-300]
DPE-400-20	N [lbf]	445-890 [100-200]
Total Stroke:		
DPE-400-10	mm [in]	10 [0.39]
DPE-400-20	mm [in]	20 [0.78]
Actuation Time	ms	800
Temperature Range	°C [°F]	0~55° [32°~131°]
Power Requirements @ 100% Duty Cycle	watts	10
Voltage	VDC	24
DC Current (Peak)	amps	2 (max)
DC Current: (Continuous)	amps	0.4
Ingress Protection Class (IP)		IP50
Clean Room		100 (Magnalube)
Weight	kg [lbs]	2.52 [5.56]
Maximum Finger Length	mm [in]	125 [4.92]
Durability	cycles	3 Million



CLICK OR SCAN

To view full catalog pages on this product

DPE-200 MEDIUM-DUTY

Electric Parallel Grippers

How To Order



Shown with customer supplied fingers.

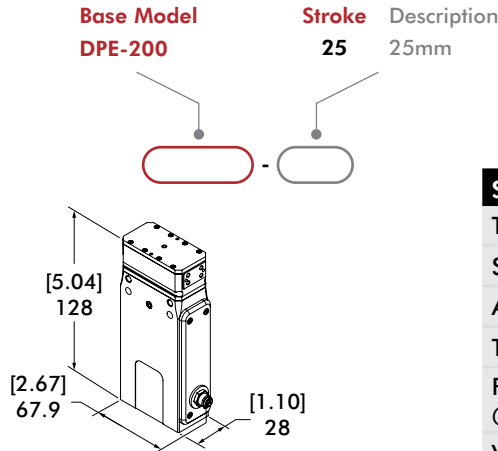

Specifications	Units	DPE-200-25
Total Grip Force	N [lbf]	111 [25]
Stroke	mm [in]	25 [0.98]
Actuation Time	ms	250
Temperature Range	°C [°F]	5°~60° [41°~140°]
Power Requirement @ 100% duty cycle	W	4.2
Voltage	VDC	24
Current - Peak	amps	1.5 (max)
Current - Continuous	amps	0.175
Ingress Protection Class (IP)		IP54
Clean Room		1000 (Krytox)
Weight	kg [lbs]	0.53 [1.16]
Max Finger Length	mm [in]	76.2 [3.00]
Durability	cycles	20 Million

Accessories

Power and Sensor Accessories	Part Number
PNP Magneto-Resistive Position Sensor	OHSP-017
NPN Magneto-Resistive Position Sensor	OHSN-017
Quick Disconnect Sensor Cable, 5m Long	CABL-013
4-wire Power and Signal Cable, 5m Long	CABL-046

* Sensor and cable sold separately.

How To Order



Shown with customer supplied fingers.

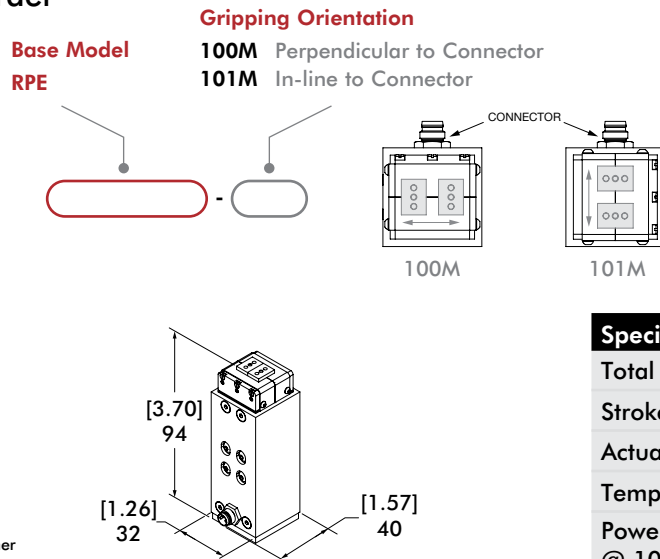

RPE-100 LIGHT-DUTY



Specifications	Units	RPE-100M/101M
Total Grip Force	N [lbf]	5 [1.1]
Stroke	mm [in]	4 [0.16]
Actuation Time	ms	100
Temperature Range	°C [°F]	5°~50° [40°~120°]
Power Requirement @ 100% duty cycle	W	40 (Peak)
Voltage	VDC	24
Current - Peak	amps	1.5 (max)
Current - Continuous	amps	0.175
Ingress Protection Class (IP)		IP54
Clean Room		100 (Krytox)
Weight	kg [lbs]	0.23 [0.50]
Max Finger Length	mm [in]	50 [1.90]
Durability	cycles	5 Million

Accessories

Sensor Accessories	Part Number
Sensor Mounting Kit (Mounts 1 sensor)	OSMK-130
PNP Inductive Sensor with Quick Connect	OISP-019
NPN Inductive Sensor with Quick Connect	OISN-019
Quick Disconnect Sensor Cable, 2m long	CABL-010
Quick Disconnect Sensor Cable, 5m long	CABL-013

* Sensor and cable sold separately.

2P SERIES

2-Jaw Precision Parallel Grippers

CLICK OR SCAN

To view full catalog pages on this product



How To Order



Note: See catalog for complete options information.

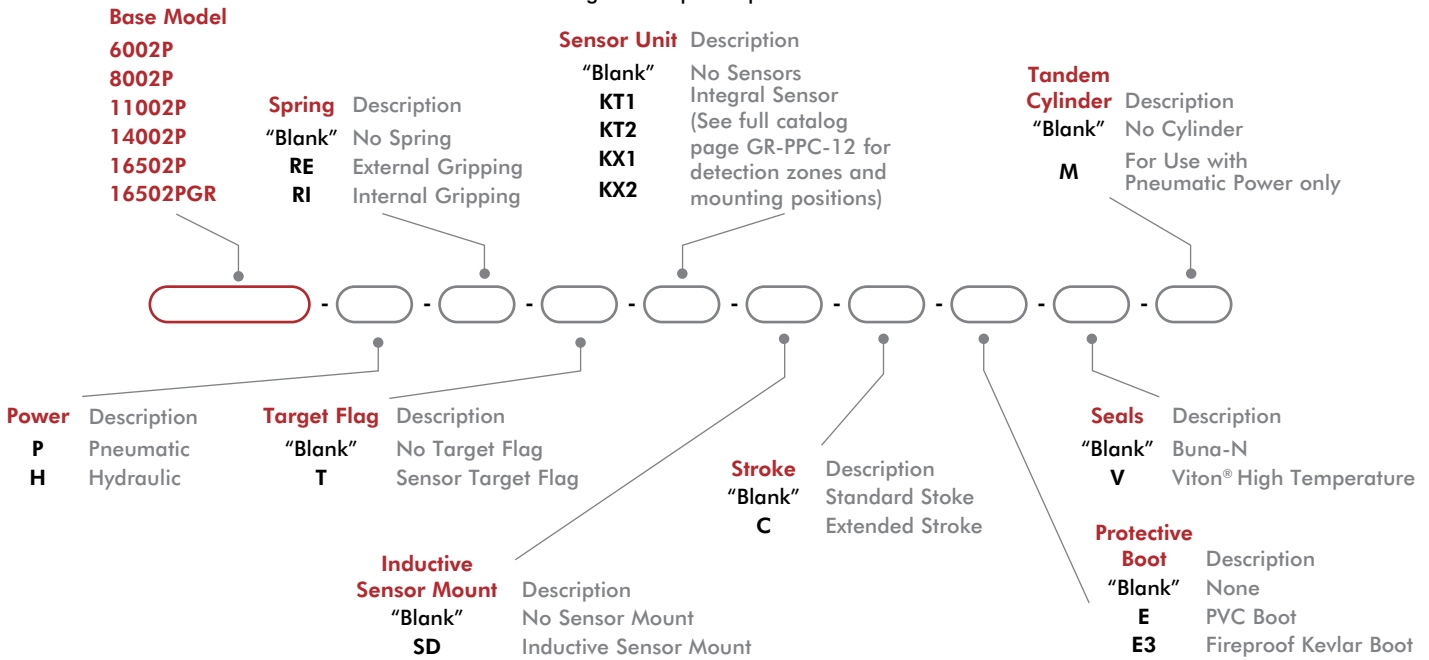

Size	Seal Repair Kits			Protective Boots	
	Buna-N	Viton®	Hydraulic	PVC - Brown or Black	Fireproof KEVLAR - Red
6002P	SLKT-156	SLKT-156V	SLKT-330	ER62P	E3R62P
8002P	S80	S80V	S80H	ER82P	E3R82P
11002P	S100	S110V	S110H	ER112P	E3R112P
14002P	SLKT-333	SLKT-333	SLKT-334	KP-311	KP-313
16502P	SLKT-335	SLKT-335V	SLKT-336	KP-314	KP-316
16502PGR				N/A	KENVE2-21384



CLICK OR SCAN
To view full
catalog pages
on this product

2P SERIES

2-Jaw Precision Parallel Grippers

Basic Unit Dimensions

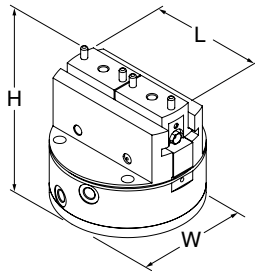

Size	L	L -C	W	H
6002P	72 [2.83]	78 [3.07]	60 [2.36]	77 [3.03]
8002P	91.6 [3.61]	98.4 [3.87]	80 [3.15]	78 [3.07]
11002P	126 [4.96]	136 [5.35]	110 [4.33]	106 [4.17]
14002P	165 [6.50]	179 [7.05]	140 [5.51]	137 [5.39]
16502P	194 [7.64]	204 [8.03]	165 [6.50]	169 [6.65]
16502PGR	210 [8.27]	--	165 [6.50]	262 [10.31]

Technical Data

Specifications	Units	6002P-P	6002P-P-C	8002P-P	8002P-P-C	11002P-P	11002P-P-C
Grip Force (F6+R)1, 6 bar [87 psi], Springs Mid-Way, L=0	N [lb]	694 [156]	432 [97]	1946 [437]	1256 [282]	3043 [684]	2030 [456]
Grip Force (F0+R)2, 0 bars, Springs Mid-Way, L=0	N [lb]	176 [40]	109 [24]	635 [143]	410 [92]	965 [217]	644 [145]
Total Stroke	mm [in]	10 [0.39]	16 [0.63]	13 [0.51]	20 [0.79]	20 [0.79]	30 [1.18]
Weight	kg [lbs]	0.51 [1.12]		0.84 [1.85]		2.04 [4.50]	
Pressure Range	bar [psi]	w/Spring 2-7 Bar [30-100 psi], w/o spring 4-7 Bar [60-100 psi]					
Displacement	cm ³ [in ³]	12 [0.73]		35 [2.14]		87 [5.31]	
Temperature Range		Buna-N -35°~80° [-30°~180°], Viton® -30°~150° [-20°~300°]					
Actuation (open/close)	sec	0.07		0.08		0.10	

Specifications	Units	14002P-P	14002P-P-C	16502P-P	16502P-P-C	1650PGR-P	
Grip Force (F6+R)1, 6 bar [87 psi], Springs Mid-Way, L=0	N [lb]	6232 [1400]	4031 [906]	11475 [2579]	6878 [1546]	11475 [2579]	
Grip Force (F0+R)2, 0 bars, Springs Mid-Way, L=0	N [lb]	2305 [518]	1490 [335]	3825 [860]	2292 [515]	3825 [860]	
Total Stroke	mm [in]	26 [1.02]	40 [1.57]	30 [1.18]	50 [1.97]	30 [0.39]	
Weight	kg [lbs]	4.2 [9.26]		8.74 [19.26]		2.04 [4.50]	
Pressure Range	bar [psi]	w/Spring 2-7 Bar [30-100 psi], w/o spring 4-7 Bar [60-100 psi]					
Displacement	cm ³ [in ³]	220 [13.43]		494 [30.15]		494 [30.15]	
Temperature Range		Buna-N -35°~80° [-30°~180°], Viton® -30°~150° [-20°~300°]					
Actuation (open/close)	sec	0.16		0.29		0.29	

Accessories

Sensor Accessories	Model Numbers	Part Number	Qty/Unit
M8 Inductive Sensor PNP with M8 Connector	6002P, 8002P, 11002P	OISP-011	1-4
M8 Inductive Sensor NPN with M8 Connector	6002P, 8002P, 11002P	OISN-011	1-4
M8 Inductive Sensor PNP with M12 Connector	14002P, 16502P	OISP-017	1-4
M8 Inductive Sensor NPN with M12 Connector	14002P, 16502P	OISN-017	1-4
M8 Quick Disconnect 2 Meter Cable Length*	6002P, 8002P, 11002P	CABL-010	1-4
M12 Quick Disconnect 2 Meter Cable Length*	14002P, 16502P	CABL-014	1-4
Inductive Sensor Kit (1 holder + 1 flag)	6002P, 8002P	SD60-80P	1-2
Inductive Sensor Kit (1 holder + 1 flag)	11002P	SD110P	1-2
Inductive Sensor Kit (1 holder + 1 flag)	14002P	OSMK-114	1-2
Inductive Sensor Kit (1 holder + 1 flag)	16502P	OSMK-115	1-2

*Sensor and cable sold separately.

DGC/GC SERIES

2-Jaw Precision Parallel Grippers

How To Order

CLICK OR SCAN

To view full
catalog pages
on this product



Base Model

DGC-25 GC-85
DGC-45 GC-105
DGC-65

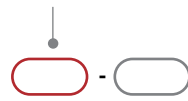

Seals	Description
"Blank"	Buna-N
V	Viton® High Temperature

Size	Seal Repair Kits	
	Buna-N	Viton®
25	SLKT-319	SLKT-319V
45	SLKT-321	SLKT-321V
65	SLKT-323	SLKT-323V
85	SLKT-325	SLKT-325V
105	SLKT-327	SLKT-327V



CLICK OR SCAN

To view full catalog pages on this product

DGC/GC SERIES

2-Jaw Precision Parallel Grippers

Basic Unit Dimensions

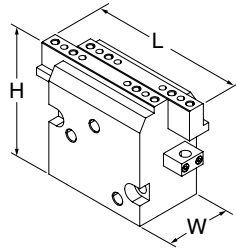

Size	L	W	H
25	75 [2.95]	38 [1.50]	55 [2.17]
45	95 [3.74]	42 [1.65]	70 [2.76]
65	125 [4.92]	53 [2.09]	90 [3.54]
85	155 [6.10]	67.5 [2.66]	120 [4.72]
105	190 [7.48]	85.5 [3.37]	145 [5.71]

Technical Data

Specifications	Units	25	45	65	85	105
Total Rated Grip Force F @ 100 psi [7 bar]	N [lb]	474 [106]	481 [108]	796 [179]	1480 [333]	2318 [521]
Total Stroke	mm [in]	20 [0.787]	30 [1.181]	40 [1.575]	50 [1.968]	60 [2.362]
Weight	kg [lbs]	0.35 [0.77]	0.60 [1.32]	1.30 [2.87]	2.20 [4.85]	4.31 [9.50]
Pressure Range	bar [psi]	3-7 [45-100]				
Displacement	cm ³ [in ³]	16 [0.98]	29 [1.77]	62 [3.78]	136 [8.30]	261 [15.93]
Temperature Range (Buna-N seals)	°C [°F]	-35°~80° [-30°~180°]				
Temperature Range (Viton® seals)	°C [°F]	-30°~150° [-20°~300°]				
Actuation (open/close)	sec	0.20	0.25	0.35	0.50	0.70

Accessories

Sensor Accessories	Model Numbers	Part Number	Qty/Unit
4mm NPN Inductive Sensor with Quick Disconnect*	25, 45	OISN-014	1-2
4mm PNP Inductive Sensor with Quick Disconnect*	25, 45	OISP-014	1-2
8mm NPN Inductive Sensor with Quick Disconnect*	65, 85	OISN-011	1-2
8mm PNP Inductive Sensor with Quick Disconnect*	65, 85	OISP-011	1-2
12mm NPN Inductive Sensor with Quick Disconnect*	105	OISN-017	1-2
12mm PNP Inductive Sensor with Quick Disconnect*	105	OISP-017	1-2
Quick Disconnect 2 Meter Cable Length*	24, 45, 65, 85	CABL-010	1-2
Quick Disconnect 5 Meter Cable Length*	24, 45, 65, 85	CABL-013	1-2
Quick Disconnect 2 Meter Cable Length*	105	CABL-014	1-2
Quick Disconnect 5 Meter Cable Length*	105	CABL-018	1-2

*Sensor and cable sold separately.

DPL SERIES

2-Jaw Precision Parallel Grippers

CLICK OR SCAN

To view full catalog pages on this product



How To Order

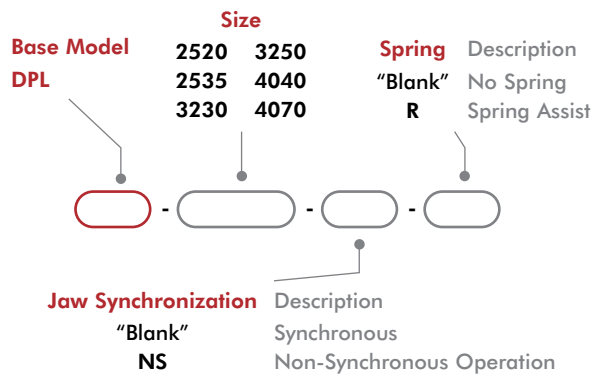
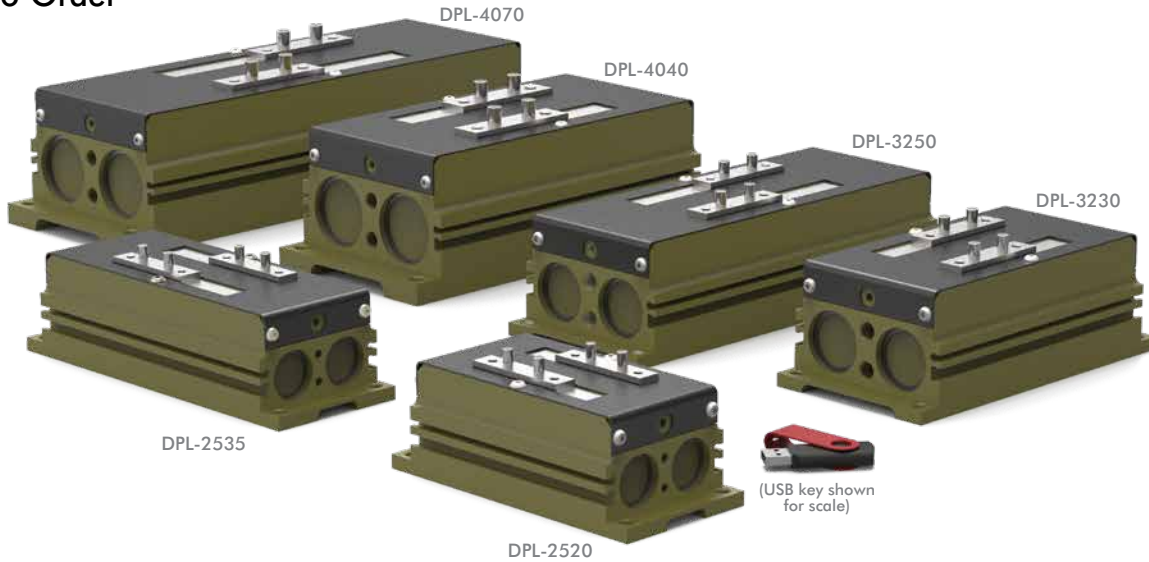

Size	Seal Repair Kit Buna-N	Rear Inlet Seal Repair Kit	In-line Jaw Mounting Kit	Inductive Sensor Mtg Kit (3 Holder/2 Flags)
2520	SLKT-233	SLKT-316	ODPL-001	OSMK-099
2535			ODPL-002	
3230	ODPL-003		OSMK-100	
3250	ODPL-004			
4040	ODPL-005		OSMK-101	
4070	ODPL-006			

Basic Unit Dimensions

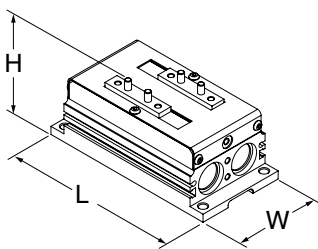

Size	L	W	H
2520	152 [5.98]	75 [2.95]	65 [2.56]
2535	197 [7.76]		
3230	186 [7.32]	93 [3.66]	74 [2.91]
3250	246 [9.69]		
4040	238 [9.37]	112 [4.41]	91 [3.58]
4070	328 [12.91]		



CLICK OR SCAN
To view full
catalog pages
on this product

Technical Data

Specifications	Units	2520	2535	3230
Total Rated Grip Force F @ 100 psi	N [lb]	811 [182]	768 [173]	1359 [306]
Total Stroke	mm [in]	40 [1.57]	70 [2.76]	60 [2.36]
Weight	kg [lbs]	1.38 [3.04]	1.80 [3.97]	2.26 [4.98]
Pressure Range	bar [psi]	w/Spring 2-7 Bar [30-100 psi], w/o spring 4-7 Bar [60-100 psi]		
Displacement	cm ³ [in ³]	39 [2.38]	68 [4.15]	96 [5.86]
Temperature Range	°C [°F]	-20°~80° [-4°~180°]		
Actuation	sec	0.3	0.4	0.4

Specifications	Units	3250	4040	4070
Total Rated Grip Force F @ 100 psi	N [lb]	1306 [294]	2035 [457]	2029 [456]
Total Stroke	mm [in]	100 [3.94]	80 [3.15]	140 [5.51]
Weight	kg [lbs]	3.02 [6.66]	4.30 [9.48]	6.00 [13.23]
Pressure Range	bar [psi]	w/Spring 2-7 Bar [30-100 psi], w/o spring 4-7 Bar [60-100 psi]		
Displacement	cm ³ [in ³]	160 [9.96]	200 [12.20]	350 [21.36]
Temperature Range	°C [°F]	-20°~80° [-4°~180°]		
Actuation	sec	0.5	0.5	0.7

Accessories

Sensor Accessories	Model Numbers	Part Number	Qty/Unit
M8 PNP Magneto Resistive Sensor with Quick Disconnect*	All Models	OHSP-017	1-3
M8 NPN Magneto Resistive Sensor with Quick Disconnect*	All Models	OHSN-017	1-3
M8 PNP Magneto Resistive Sensor (90° barrel) w/Qk. Disc.*	All Models	OHSP-011	1-3
M8 NPN Magneto Resistive Sensor (90° barrel) w/Qk. Disc.*	All Models	OHSN-011	1-3
M8 PNP Inductive Sensor with Quick Disconnect*	2520, 2535, 3230, 3250	OISP-011	1-3
M8 NPN Inductive Sensor with Quick Disconnect*	2520, 2535, 3230, 3250	OISN-011	1-3
M12 PNP Inductive Sensor with Quick Disconnect*	4040, 4070	OISP-017	1-3
M12 NPN Inductive Sensor with Quick Disconnect*	4040, 4070	OISN-017	1-3
Inductive Sensor Mounting Kit (3 Holders + 2 Flags)	See Datasheet		1
M8 Quick Disconnect 2 Meter Cable Length*	All Models	CABL-010	1-3
M8 Quick Disconnect 5 Meter Cable Length*	All Models	CABL-013	1-3
M12 Quick Disconnect 2 Meter Cable Length*	4040, 4070	CABL-014	1-3
M12 Quick Disconnect 5 Meter Cable Length*	4040, 4070	CABL-018	1-3

Pneumatic Accessories	Model Numbers	Part Number	Qty/Unit
Fitting Push-in Straight M5 - 6mm O.D. Tube	2520, 2535	PLFT-037	1-2
Fitting Push-in 90° Elbow M5 - 6mm O.D. Tube	2520, 2535	PLFT-041	1-2
Fitting Push-in Straight G1/8 - 6mm O.D. Tube	3230, 3250, 4040, 4070	PLFT-038	1-2
Fitting Push-in 90° Elbow G1/8 - 6mm O.D. Tube	3230, 3250, 4040, 4070	PLFT-042	1-2

*Sensor and cable sold separately.

DPP SERIES

2-Jaw Precision Parallel Grippers

CLICK OR SCAN

To view full catalog pages on this product



How To Order

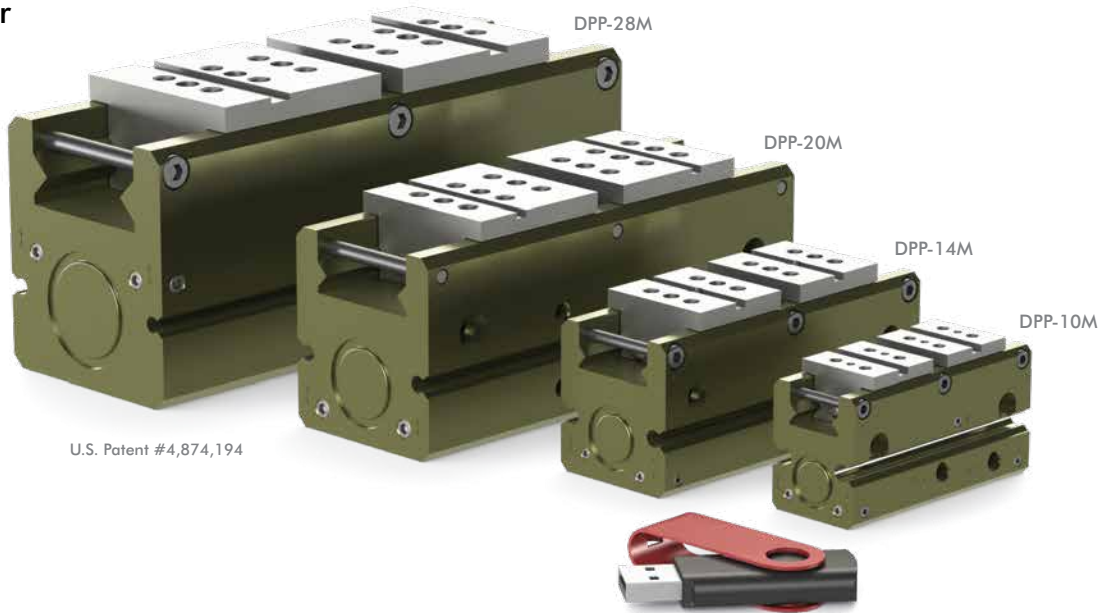

U.S. Patent #4,874,194

(USB key shown for scale)

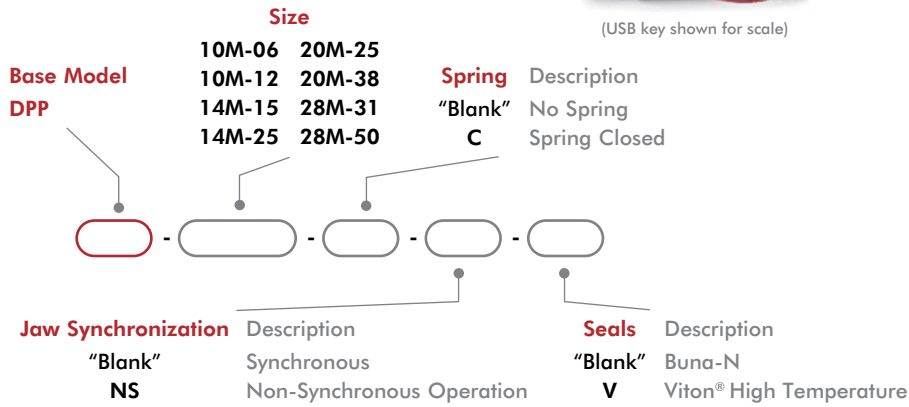

Size	Seal Repair Kits		
	Buna-N	Viton®	Manifold (Viton®)
10M	SLKT-343	SLKT-343V	SLKT-241V
14M	SLKT-344	SLKT-344V	SLKT-242V
20M	SLKT-345	SLKT-345V	SLKT-243V
28M	SLKT-346	SLKT-346V	

Basic Unit Dimensions

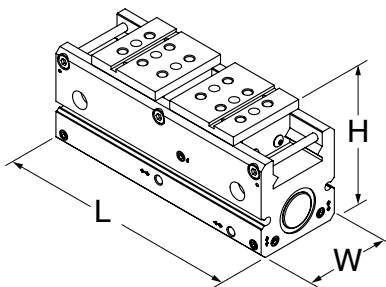

Size	L	W	H
10M-6	62.9 [2.48]	25 [0.98]	34.67 [1.36]
10M-12	73.7 [2.90]		
14M-15	90.2 [3.55]	34 [1.34]	42.21 [1.66]
14M-25	118.7 [4.67]		
20M-25	129 [5.08]	46 [1.81]	55.63 [2.19]
20M-38	175.5 [6.91]		
28M-31	162.3 [6.39]	58 [2.28]	72.54 [2.86]
28M-50	221.5 [8.72]		



CLICK OR SCAN
To view full
catalog pages
on this product

Technical Data

Specifications	Units	10M-6	10M-12	14M-15	14M-25
Total Rated Grip Force F @ 100 psi [7 bar]*	N [lb]	120 [27]		227 [51]	214 [48]
Total Stroke	mm [in]	6.4 [0.25]	12.7 [0.50]	15.9 [0.63]	25.4 [1.00]
Weight	kg [lbs]	0.16 [0.35]	0.20 [0.45]	0.48 [1.05]	0.57 [1.25]
Pressure Range (without spring)	bar [psi]	0.3-7 [5-100]			
Pressure Range (with spring)	bar [psi]	1.4-7 [20-100]		3.4-7 [50-100]	
Displacement	cm ³ [in ³]	0.5 [0.032]	1.1 [0.065]	2.5 [0.156]	4.1 [0.249]
Temperature Range (Buna-N seals)	°C [°F]	-35°~80° [-30°~180°]			
Temperature Range (Viton® seals)	°C [°F]	-30°~120° [-20°~250°]			
Actuation (without spring)	sec	0.10	0.11	0.15	0.19
Actuation (with spring)	sec	0.11	0.12	0.16	0.20

Specifications	Units	20M-25	20M-38	28M-31	28M-50
Total Rated Grip Force F @ 100 psi [7 bar]*	N [lb]	458 [103]	449 [101]	912 [205]	934 [210]
Total Stroke	mm [in]	25.4 [1.00]	38.1 [1.50]	31.8 [1.50]	50.8 [2.00]
Weight	kg [lbs]	1.02 [2.25]	1.41 [3.10]	2.06 [4.55]	2.83 [6.25]
Pressure Range (without spring)	bar [psi]	0.3-7 [5-100]			
Pressure Range (with spring)	bar [psi]	2.8-7 [40-100]	2.1-7 [30-100]	2.1-7 [30-100]	2.8-7 [40-100]
Displacement	cm ³ [in ³]	8.5 [0.519]	12.8 [0.779]	20.4 [1.243]	32.6 [1.998]
Temperature Range (Buna-N seals)	°C [°F]	-35°~80° [-30°~180°]			
Temperature Range (Viton® seals)	°C [°F]	-30°~120° [-20°~250°]			
Actuation (without spring)		0.20	0.24	0.19	0.23
Actuation (with spring)		0.22	0.29	0.25	0.30

*With springs

Accessories

Sensor Accessories	Model Numbers	Part Number	Qty/Unit
Inductive Sensor Mounting Kit (Mounts 2 sensors)	10M, 14M	OSMK-119	1-2
Inductive Sensor Mounting Kit (Mounts 2 sensors)	20M, 28M	OSMK-120	1-2
NPN Inductive Sensor (with Qk. Disc.)*	All Models	OISN-014	1-4
PNP Inductive Sensor (with Qk. Disc.)*	All Models	OISP-014	1-4
NPN Magneto Resistive Sensor (with Qk. Disc.)*†	All Models	OHSN-017	1-4
PNP Magneto Resistive Sensor (with Qk. Disc.)*†	All Models	OHSP-017	1-4
NPN Magneto Resistive Sensor 90° (with Qk. Disc.)*†	All Models	OHSN-011	1-4
PNP Magneto Resistive Sensor 90° (with Qk. Disc.)*†	All Models	OHSP-011	1-4
Quick Disconnect Cable (2 meters long)*	All Models	CABL-010	1-4
Quick Disconnect Cable (5 meters long)*	All Models	CABL-013	1-4
Pneumatic Accessories	Model Numbers	Part Number	Qty/Unit
Adjustable Flow Control-M3 Elbow-3MM OD Tube Push-in Style	10M, 14M	VLVF-018	1-2
Adjustable Flow Control-M5 Elbow-6MM OD Tube Push-in Style	20M, 28M	VLVF-008	1-2
Fail Safe Valve - M5	All Models	OFSV-004	1

*Sensor and cable sold separately. †Piston magnet standard.

RP-P SERIES

2-Jaw Precision Parallel Grippers

CLICK OR SCAN

To view full catalog pages on this product



How To Order

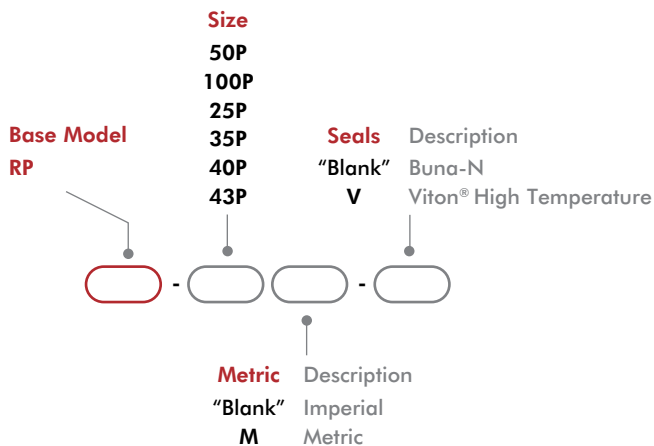

Size	Seal Repair Kits		Inductive Sensor Mtg Kit (mounts 2 sensors)
	BunaN	Viton®	
50P	SLKT353	SLKT353V	OSMK003
100P	SLKT037	SLKT037V	OSMK004
25P	SLKT046	SLKT046V	OSMK004
35P	SLKT049	SLKT049V	OSMK023
40P	SLKT050	SLKT050V	OSMK023
43P	SLKT051	SLKT051V	OSMK033

Basic Unit Dimensions

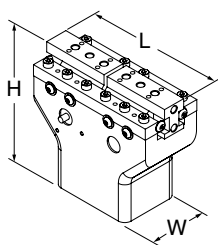

Size	L	W	H
50P	57 [2.24]	25.4 [1.00]	46.7 [1.84]
100P	83 [3.27]	59.4 [2.34]	59.4 [2.34]
25P	108 [4.25]	31.8 [1.25]	81.1 [3.19]
35P	143 [5.63]	50.8 [2.00]	103.2 [4.06]
40P	178 [7.01]	[2.25] 57.2	125 [4.92]
43P	292 [11.50]	74.7 [2.94]	175 [6.89]

**CLICK OR SCAN**

To view full catalog pages on this product

RP-P SERIES

2-Jaw Precision Parallel Grippers

Technical Data

Specifications	Units	50P	100P	25P	35P	40P	43P
Total Rated Grip Force F @ 100 psi [7 bar]	N [lb]	107 [24]	160 [36]	356 [80]	778 [175]	890 [200]	2224 [500]
Total Stroke	mm [in]	12.7 [0.50]	25.4 [1.00]	28.7 [1.13]	25.4 [1.00]	50.8 [2.00]	76.2 [3.00]
Weight	kg [lbs]	0.14 [0.31]	0.23 [0.50]	0.45 [1.0]	1.6 [3.5]	2.7 [6.0]	7.3 [16]
Pressure Range	bar [psi]	0.3-7 [5-100]					
Displacement	cm ³ [in ³]	1.64 [0.100]	3.6 [0.220]	8.2 [0.500]	17.0 [1.036]	28.0 [1.710]	120.6 [7.360]
Temperature Range (Buna-N seals)	°C [°F]	-35°~80° [-30°~180°]					
Temperature Range (Viton® seals)	°C [°F]	-30°~120° [-20°~250°]					
Actuation (open/close)	sec	0.14	0.18	0.20	0.33	0.39	0.59

Accessories

Sensor Accessories	Model Numbers	Part Number	Qty/Unit
3mm NPN Inductive Sensor with Quick Disconnect*	RP-50P	OISN-019	1-2
3mm PNP Inductive Sensor with Quick Disconnect*	RP-50P	OISP-019	1-2
3mm NPN Inductive Sensor with Quick Disconnect*	RP-100P, -25P, RP-50P, -110P, -25P	OISN-014	1-2
3mm PNP Inductive Sensor with Quick Disconnect*	RP-100P, -25P, RP-50P, -110P, -25P	OISP-014	1-2
Inductive Sensor Mounting Kit for (mounts 2 sensors)	See Datasheet		1
Quick Disconnect 2 Meter Cable Length*	All Models	CABL-010	1-2
Quick Disconnect 5 Meter Cable Length*	All Models	CABL-013	1-2

Pneumatic Accessories	Model Numbers	Part Number	Qty/Unit
Fail Safe Valve (Imperial)	RP-50P, -110P, -25P	OFSV-001	1
Fail Safe Valve (Metric)	RP-50P, -110P, -25P	OFSV-004	1
Fail Safe Valve (Imperial)	RP-35P, -40P, -43P	OFSV-002	1
Fail Safe Valve (Metric)	RP-50P, -110P, -25P	OFSV-005	1
Stroke Limited Opening Valve (LTD)	RP-35P, -40P, -43P	OLTD-001	1
Stroke Limited Opening Valve (LTD)	RP-50P, -110P, -25P	OLTD-002	1

*Sensor and cable sold separately.

RPL/RPLC SERIES

2-Jaw Precision Parallel Grippers

CLICK OR SCAN

To view full catalog pages on this product



How To Order

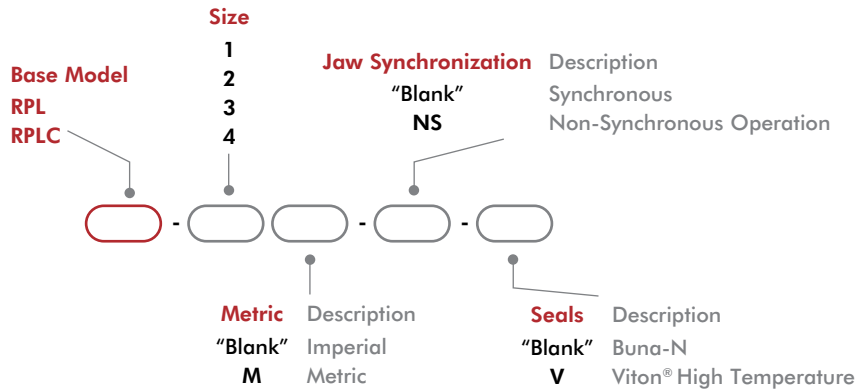

Size	Seal Repair Kits	
	Buna-N	Viton®
1	SLKT-010	SLKT-010V
2		
3	SLKT-012	SLKT-012V
4		

**CLICK OR SCAN**

To view full catalog pages on this product

RPL/RPLC SERIES

2-Jaw Precision Parallel Grippers

Basic Unit Dimensions

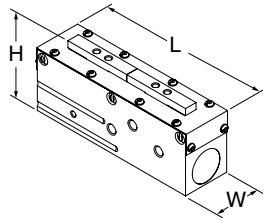

Size	L	W	H
1	44.5 [1.75]	19.1 [0.75]	29.5 [1.16]
2	59.5 [2.34]		
3	80 [3.15]	22.2 [0.87]	32.6 [1.28]
4	98.1 [3.86]		

Technical Data

Specifications	Units	1	2	3	4
Total Rated Grip Force F @ 100 psi [7 bar]	N [lb]	116 [26]		160 [36]	
Total Stroke	mm [in]	6.4 [0.25]	12.7 [0.50]	19.1 [0.75]	25.4 [1.00]
Weight	kg [lbs]	0.07 [0.16]	0.09 [0.20]	0.15 [0.32]	0.17 [0.38]
Pressure Range	bar [psi]	0.3-7 [5-100]			
Displacement	cm ³ [in ³]	0.6 [0.038]	1.2 [0.075]	2.4 [0.147]	3.2 [0.196]
Temperature Range (Buna-N seals)	°C [°F]	-35°~80° C [-30°~180° F]			
Temperature Range (Viton® seals)	°C [°F]	-30°~120° C [-20°~250° F]			
Actuation (open/close)	sec	0.10	0.13	0.14	0.19

Accessories

Sensor Accessories	Model Numbers	Part Number	Qty/Unit
Sensor Mounting Kit for Imperial & Metric Units (mounts 2 sensors)	All Models	OSMK-008	1
NPN Magneto Resistive Sensor with Quick Disconnect*	All Models	OHSN-017	1-2
PNP Magneto Resistive Sensor with Quick Disconnect*	All Models	OHSP-017	1-2
Quick Disconnect 2 Meter Cable Length*	All Models	CABL-010	1-2
Quick Disconnect 5 Meter Cable Length*	All Models	CABL-013	1-2

Pneumatic Accessories	Model Numbers	Part Number	Qty/Unit
Fail Safe Valve (Imperial)	All Models	OFSV-001	1
Fail Safe Valve (Metric)	All Models	OFSV-004	1

* Sensor and cable sold separately.

CP SERIES

2-Jaw General Industrial Grippers

How To Order

CLICK OR SCAN

To view full catalog pages on this product



See page 5-8 for product availability in your region.

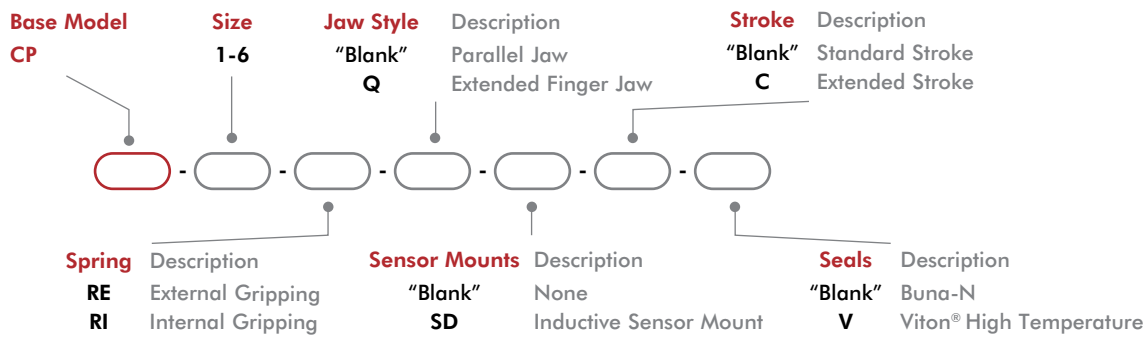
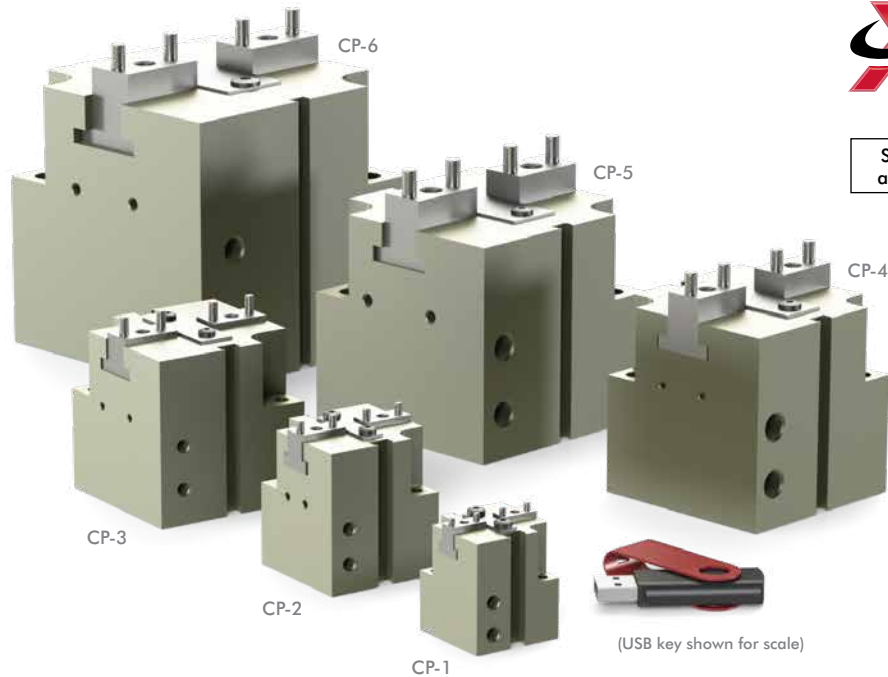

Size	Seal Repair Kits		Repair Kits (screws, springs, seals) -C		Inductive Sensor Mtg Kit (mounts 2 sensors) -SD
	Buna-N	Viton®	Buna-N	Viton®	
1	SCP1	SCP1V	KSCP1	KSCP1V	N/A
2	SCP2	SCP2V	KSCP2	KSCP2V	SDCP2
3	SCP3	SCP3V	KSCP3	KSCP3V	SDCP3
4	SCP4	SCP4V	KSCP4	KSCP4V	SDCP4
5	SCP5	SCP5V	KSCP5	KSCP5V	SDCP5
6	SCP1	SCP1V	KSCP1	KSCP1V	SDCP6

Basic Unit Dimensions

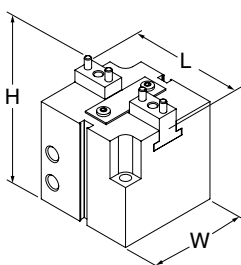

Size	L	L -C	W	H
1	37.6 [1.48]	42 [1.65]	30 [1.18]	39.2 [1.54]
2	51.4 [2.02]	58.2 [2.29]	40 [1.57]	51.5 [2.03]
3	70 [2.76]	81.2 [3.20]	55 [2.17]	67 [2.64]
4	85 [3.35]	96 [3.78]	65 [2.56]	74 [2.91]
5	102 [4.02]	120 [4.72]	80 [3.15]	91 [3.58]
6	125 [4.92]	141 [5.55]	100 [3.94]	114 [4.49]



CLICK OR SCAN
To view full
catalog pages
on this product

Technical Data

Specifications	Units	1	1-C	2	2-C	3	3-C
Total Rated Grip Force F @ 100 psi [7 bar] w/o Spring Assist	N [lbs]	89 [20]	60 [13]	238 [53]	161 [36]	677 [152]	407 [91]
Total Rated Grip Force F @ 100 psi [7 bar] with Spring Assist	N [lbs]	15 [3]	10 [2]	43 [10]	29 [7]	161 [36]	97 [22]
Total Stroke	mm [in]	4 [0.16]	6 [0.24]	6 [0.24]	9 [0.35]	10 [0.39]	16 [0.63]
Weight	kg [lbs]	0.09 [0.20]	0.09 [0.20]	0.21 [0.46]	0.20 [0.44]	0.45 [0.99]	0.47 [1.04]
Pressure Range w/o Spring	bar [psi]	2-10 [29-145]					
Pressure Range with Spring	bar [psi]	2.5-10 [36-145]					
Displacement	cm ³ [in ³]	0.7 [0.04]		2.7 [0.16]		11.7 [0.71]	
Temperature Range	°C [°F]	-35°~80° [-30°~180°]					
Actuation (open/close)	sec	0.06				0.07	

Specifications	Units	4	4-C	5	5-C	6	6-C
Total Rated Grip Force F @ 100 psi [7 bar] w/o Spring Assist	N [lbs]	1016 [228]	665 [149]	1591 [358]	1081 [243]	2749 [618]	2092 [470]
Total Rated Grip Force F @ 100 psi [7 bar] with Spring Assist	N [lbs]	222 [50]	145 [33]	322 [72]	219 [49]	711 [160]	541 [122]
Total Stroke	mm [in]	13 [0.51]	20 [0.79]	18 [0.71]	27 [1.06]	24 [0.94]	32 [1.26]
Weight	kg [lbs]	0.73 [1.61]	0.75 [1.65]	1.25 [2.76]	1.27 [2.80]	2.5 [5.51]	2.56 [5.64]
Pressure Range w/o Spring	bar [psi]	2-10 [29-145]					
Pressure Range with Spring	bar [psi]	2.5-10 [36-145]					
Displacement	cm ³ [in ³]	24.2 [1.48]		53.5 [3.26]		114.8 [7.01]	
Temperature Range	°C [°F]	-35°~80° [-30°~180°]					
Actuation (open/close)	sec	0.07		0.09		0.12	

Accessories

Sensor Accessories	Model Numbers	Part Number	Qty/Unit
PNP Sensor with 0.3m Output Cable with 90° with M8 connector*	All Models	D1	1-2
NPN Sensor with 0.3m Output Cable with 90° with M8 connector*	CP-2, -3, -4, -5, -6	D10	1-2
PNP Sensor with 0.3m Output Cable with M8 connector*	All Models	D4	1-2
NPN Sensor with 0.3m Output Cable with M8 connector*	CP-2, -3, -4, -5, -6	D7	1-2
Inductive Sensor Mounting Kit (mounts 2 sensors) (SD)	See Datasheet		1
Inductive PNP Sensor with M8 Connector*	CP-2, -3, -4	OISP-011	1-2
Inductive NPN Sensor with M8 Connector*	CP-2, -3, -4	OISN-011	1-2
Inductive PNP Sensor with M12 Connector*	CP-5, -6	OISP-017	1-2
Inductive NPN Sensor with M12 Connector*	CP-5, -6	OISN-017	1-2
M8 Quick Disconnect 2 Meter Cable Length*	All Models	CABL-010	1-2
M12 Quick Disconnect 2 Meter Cable Length*	All Models	CABL-014	1-2

*Sensor and cable sold separately.

DPDL SERIES

2-Jaw General Industrial Grippers

CLICK OR SCAN

To view full catalog pages on this product



How To Order

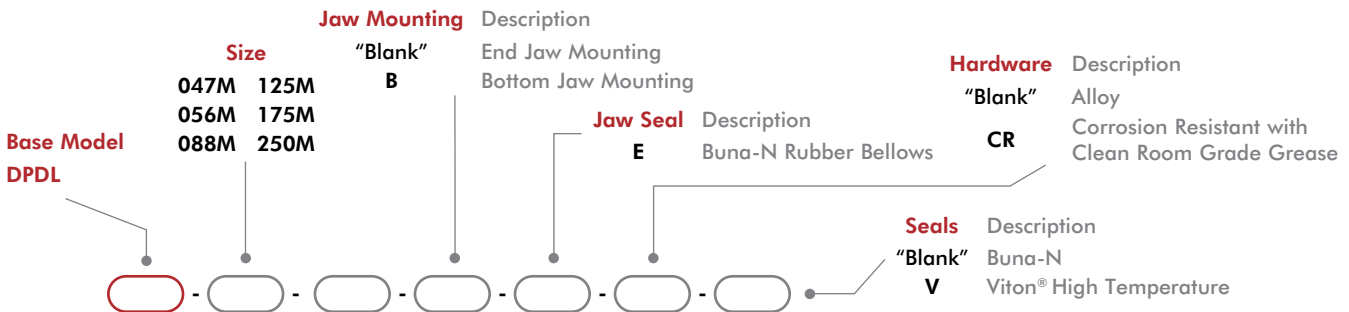
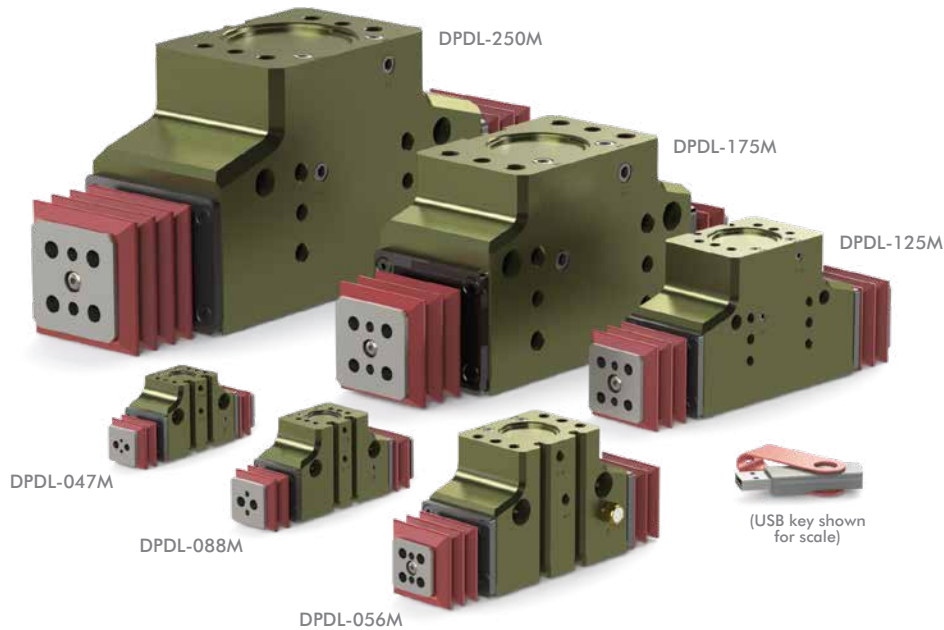

Stroke Stroke varies with size of gripper

047M	019, 025 or 038	125M	050, 075 or 100
056M	025, 038 or 050	175M	075, 100 or 150
088M	038, 050 or 075	250M	100, 150 or 200

Stroke dimensions

019	4.8mm [0.19]	050	12.7mm [0.50]	150	38.1mm [1.50]
025	6.4mm [0.25]	075	19.1mm [0.75]	200	50.8mm [2.00]
038	9.5mm [0.38]	100	25.4mm [1.00]		

Size	Seal Repair Kits			Sealed Jaw Boot Replacement (1 Buna-N Boot only)
	Buna-N	Viton®	Manifold (Viton®)	
047M	SLKT-185	SLKT-185V	SLKT-197V	SLKT-191
056M	SLKT-186	SLKT-186V		SLKT-192
088M	SLKT-187	SLKT-187V	SLKT-199V	SLKT-193
125M	SLKT-188	SLKT-188V		SLKT-194
175M	SLKT-189	SLKT-189V	SLKT-201V	SLKT-195
250M	SLKT-190	SLKT-190V		SLKT-196

Basic Unit Dimensions

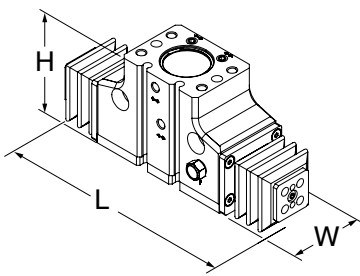

Size	L	W	H
047M	54.5 [2.16]	22.2 [.875]	32.2 [1.27]
056M	68.7 [2.70]	24.1 [.950]	37.7 [1.48]
088M	101.1 [3.98]	36.1 [1.420]	56 [2.20]
125M	128.4 [5.06]	43.2 [1.700]	68.5 [2.70]
175M	183.1 [7.21]	64.8 [2.550]	100.2 [3.94]
250M	243.8 [9.60]	79.3 [3.125]	123.3 [4.85]

**CLICK OR SCAN**To view full
catalog pages
on this product

DPDL SERIES

2-Jaw General Industrial Grippers

Specifications	Units	047M	056M	088M
Total Rated Grip Force F @ 100 psi	N [lbs]	62 [14]	98 [22]	222 [50]
Total Stroke	mm [in]	9.5 [0.38]	12.7 [0.50]	19.1 [0.75]
Weight	kg [lbs]	0.08 [0.19]	0.14 [0.32]	0.43 [0.95]
Pressure Range	bar [psi]	1.5-7 [20-100]		
Max. Vacuum for Scavenge Port	mm Hg [in. Hg]	200 [8]		
Max. Pressure for Purge Port	bar [psi]	1.4 [20]		
with -E Jaw Boot	bar [psi]	0.25 [4]		
Displacement	cm ³ [in ³]	0.6 [0.038]	1.2 [0.074]	4.4 [0.269]
Temperature Range (Buna-N seals)	°C [°F]	-35°~80° [-30°~180°]		
Temperature Range (Viton® seals)	°C [°F]	-30°~150° [-20°~300°]		
Actuation	sec	0.20	0.25	0.30

Specifications	Units	125M	175M	250M
Total Rated Grip Force F @ 100 psi	N [lbs]	445 [100]	890 [200]	1779 [400]
Total Stroke	mm [in]	25.4 [1.00]	38.1 [1.50]	50.8 [2.00]
Weight	kg [lbs]	0.90 [1.99]	2.73 [6.02]	5.46 [12.04]
Pressure Range	bar [psi]	1.5-7 [20-100]		
Max. Vacuum for Scavenge Port	mm Hg [in. Hg]	200 [8]		
Max. Pressure for Purge Port	bar [psi]	1.4 [20]		
with -E Jaw Boot	bar [psi]	0.25 [4]		
Displacement	cm ³ [in ³]	12.0 [0.730]	35.2 [2.150]	95.9 [5.850]
Temperature Range (Buna-N seals)	°C [°F]	-35°~80° [-30°~180°]		
Temperature Range (Viton® seals)	°C [°F]	-30°~150° [-20°~300°]		
Actuation	sec	0.50	0.70	0.90

Accessories

Sensor Accessories	Model Numbers	Part Number	Qty/Unit
PNP Magneto Resistive Sensor with Quick Disconnect*	047M, 056M, 088M, 125M	OHSP-017	1-2
NPN Magneto Resistive Sensor with Quick Disconnect*	047M, 056M, 088M, 125M	OHSN-017	1-2
PNP Magneto Resistive Sensor with Quick Disconnect*	175M, 250M	OHSP-015	1-2
NPN Magneto Resistive Sensor with Quick Disconnect*	175M, 250M	OHSN-015	1-2
PNP Magneto Resistive Sensor (90° barrel) w/Qk. Disc.*	047M, 056M, 088M, 125M	OHSP-011	1-2
NPN Magneto Resistive Sensor (90° barrel) w/Qk. Disc.*	047M, 056M, 088M, 125M	OHSN-011	1-2
Quick Disconnect 2 Meter Cable Length*	All Models	CABL-010	1-2
Quick Disconnect 5 Meter Cable Length*	All Models	CABL-013	1-2

Pneumatic Accessories	Model Numbers	Part Number	Qty/Unit
Plumbing Fitting - M3 male to 3mm OD Tube Push-in Style	047M, 056M	PLFT-021	1-2
Plumbing Fitting - M3 male to 2mm ID Tube Barb Style	047M, 056M	PLFT-022	1-2
Plumbing Fitting - 1/8 NPT Male to 1/8 BSPP Female	125M, 250M	PLFT-028	1-2
Adjustable Flow Control G 1/8 Elbow - 6mm OD Push-in	125M, 250M	VLVF-005	1-2
Adjustable Flow Control M5 Elbow - 6mm OD Push-in	088M, 125M	VLVF-008	1-2
Fail Safe Valve M5	088M, 125M	OFSV-004	1
Fail Safe Valve G 1/8 (1/8 BSPP)	175M, 250M	OFSV-005	1

*Sensor and cable sold separately.

Dimensions and technical information are subject to change without notice

DPDS SERIES

2-Jaw General Industrial Grippers

CLICK OR SCAN

To view full catalog pages on this product



How To Order

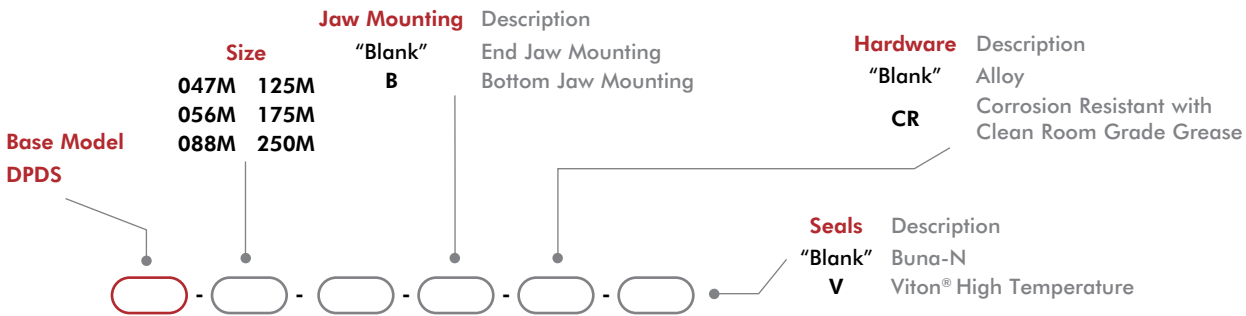
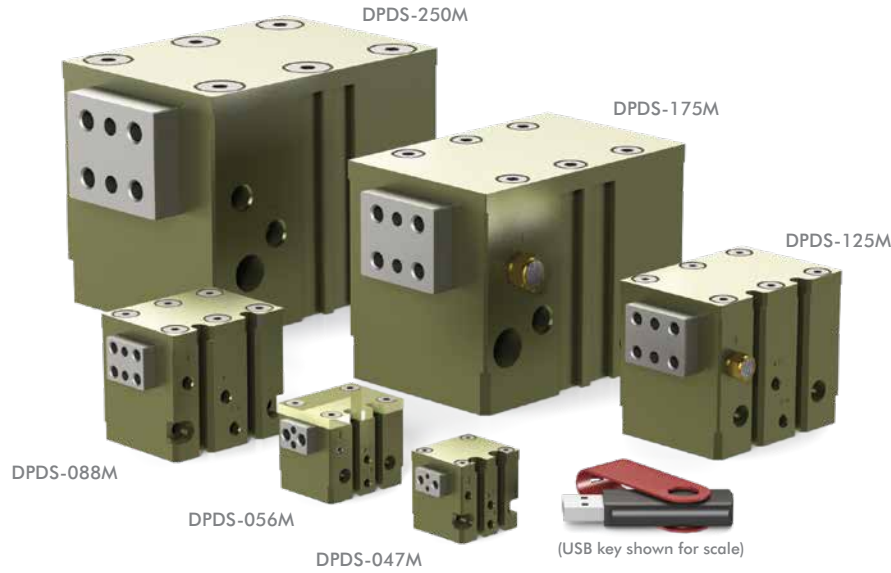

Stroke Stroke varies with size of gripper

047M	006, 009 or 013	125M	019, 025 or 038
056M	009, 013 or 019	175M	025, 038 or 050
088M	013, 019 or 025	250M	038, 050 or 075

Stroke dimensions

006	1.6mm [0.06]	019	4.8mm [0.19]	050	12.7mm [0.50]
009	2.4mm [0.09]	025	6.4mm [0.25]	075	19.1mm [0.75]
013	3.2mm [0.13]	038	9.5mm [0.38]		

Size	Seal Repair Kits		
	Buna-N	Viton®	Manifold (Viton®)
047M	SLKT-185	SLKT-185V	
056M	SLKT-186	SLKT-186V	SLKT-197V
088M	SLKT-187	SLKT-187V	
125M	SLKT-188	SLKT-188V	SLKT-199V
175M	SLKT-189	SLKT-189V	
250M	SLKT-190	SLKT-190V	SLKT-201V

Basic Unit Dimensions

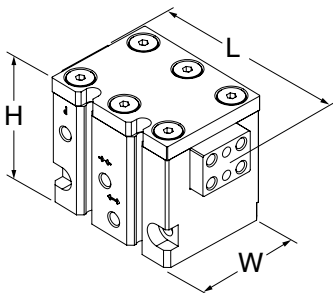

Size	L	W	H
047M	31.2 [1.23]	22.2 [0.87]	25.9 [1.02]
056M	39.8 [1.57]	24.1 [0.95]	28.9 [1.14]
088M	57.4 [2.26]	36.1 [1.42]	43.4 [1.71]
125M	73.5 [2.89]	43.2 [1.70]	52.7 [2.07]
175M	114.7 [4.52]	64.8 [2.55]	80.4 [3.17]
250M	133.1 [5.24]	79.3 [3.12]	95.5 [3.76]

**CLICK OR SCAN**To view full
catalog pages
on this product

DPDS SERIES

2-Jaw General Industrial Grippers

Specifications	Units	047M	056M	088M
Total Rated Grip Force F @ 100 psi	N [lbs]	62 [14]	98 [22]	222 [50]
Total Stroke	mm [in]	3.2 [0.13]	4.8 [0.19]	6.4 [0.25]
Weight	kg [lbs]	0.086 [0.04]	0.155 [0.07]	0.23 [0.51]
Pressure Range	bar [psi]	1.5-7 [20-100]		
Max. Vacuum for Scavenge Port	mm Hg [in. Hg]	200 [8]		
Max. Pressure for Purge Port	bar [psi]	1.4 [20]		
Displacement	cm ³ [in ³]	0.2 [0.013]	0.5 [0.028]	1.5 [0.090]
Temperature Range (Buna-N seals)	°C [°F]	-35°~80° [-30°~180°]		
Temperature Range (Viton® seals)	°C [°F]	-30°~150° [-20°~300°]		
Actuation	sec	0.13	0.16	0.20

Specifications	Units	125M	175M	250M
Total Rated Grip Force F @ 100 psi	N [lbs]	445 [100]	890 [200]	1779 [400]
Total Stroke	mm [in]	9.5 [0.38]	12.7 [0.50]	19.1 [0.75]
Weight	kg [lbs]	0.46 [1.03]	1.68 [3.70]	2.76 [6.08]
Pressure Range	bar [psi]	1.5-7 [20-100]		
Max. Vacuum for Scavenge Port	mm Hg [in. Hg]	200 [8]		
Max. Pressure for Purge Port	bar [psi]	1.4 [20]		
Displacement	cm ³ [in ³]	4.5 [0.274]	11.7 [0.717]	36.0 [2.194]
Temperature Range (Buna-N seals)	°C [°F]	-35°~80° [-30°~180°]		
Temperature Range (Viton® seals)	°C [°F]	-30°~150° [-20°~300°]		
Actuation	sec	0.30	0.40	0.50

Accessories

Sensor Accessories	Model Numbers	Part Number	Qty/Unit
PNP Magneto Resistive Sensor with Quick Disconnect*	047M, 056M, 088M, 125M	OHSP-017	1-2
NPN Magneto Resistive Sensor with Quick Disconnect*	047M, 056M, 088M, 125M	OHSN-017	1-2
PNP Magneto Resistive Sensor with Quick Disconnect*	175M, 250M	OHSP-015	1-2
NPN Magneto Resistive Sensor with Quick Disconnect*	175M, 250M	OHSN-015	1-2
PNP Magneto Resistive Sensor (90° barrel) w/Qk. Disc.*	047M, 056M, 088M, 125M	OHSP-011	1-2
NPN Magneto Resistive Sensor (90° barrel) w/Qk. Disc.*	047M, 056M, 088M, 125M	OHSN-011	1-2
Quick Disconnect 2 Meter Cable Length*	All Models	CABL-010	1-2
Quick Disconnect 5 Meter Cable Length*	All Models	CABL-013	1-2

Pneumatic Accessories	Model Numbers	Part Number	Qty/Unit
Plumbing Fitting - M3 male to 3mm OD Tube Push-in Style	047M, 056M	PLFT-021	1-2
Plumbing Fitting - M3 male to 2mm ID Tube Barb Style	047M, 056M	PLFT-022	1-2
Plumbing Fitting - 1/8 NPT Male to 1/8 BSPP Female	125M, 250M	PLFT-028	1-2
Adjustable Flow Control G 1/8 Elbow - 6mm OD Push-in	125M, 250M	VLVF-005	1-2
Adjustable Flow Control M5 Elbow - 6mm OD Push-in	088M, 125M	VLVF-008	1-2
Fail Safe Valve M5	088M, 125M	OFSV-004	1
Fail Safe Valve G 1/8 (1/8 BSPP)	175M, 250M	OFSV-005	1

* Sensor and cable sold separately.

DPG SERIES

2-Jaw General Industrial Grippers

CLICK OR SCAN

To view full catalog pages on this product



How To Order

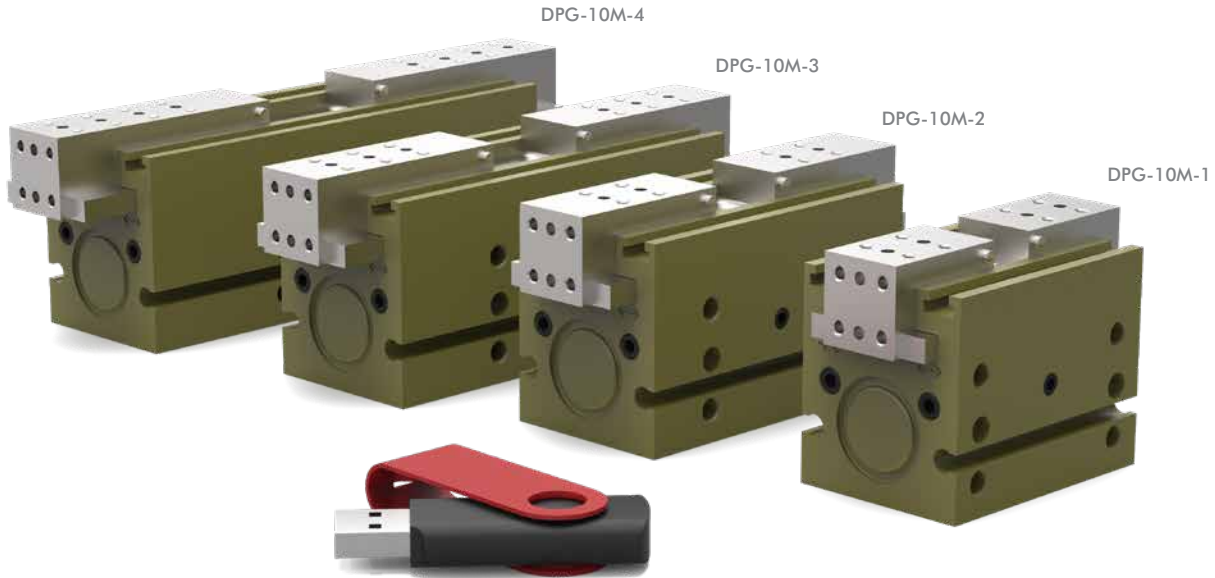

(USB key shown for scale)

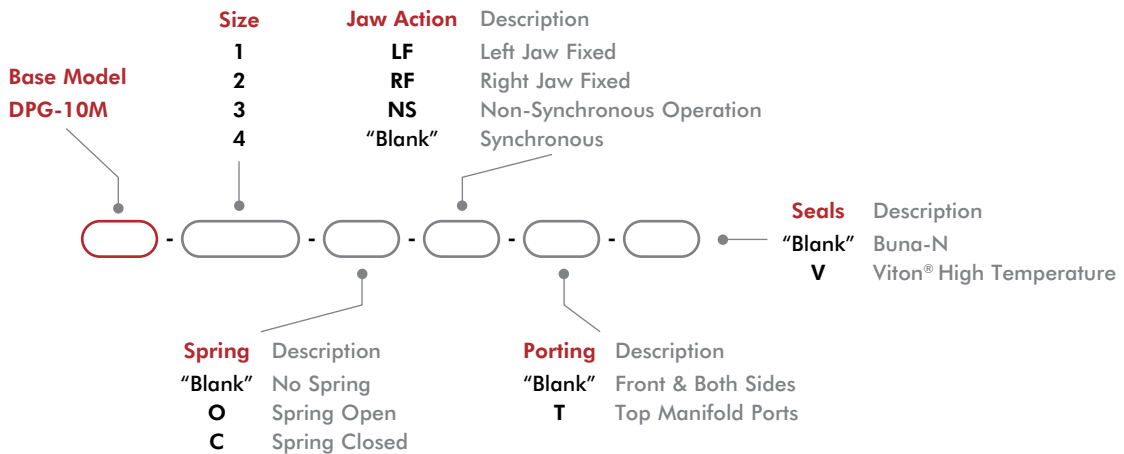

Basic Unit Dimensions

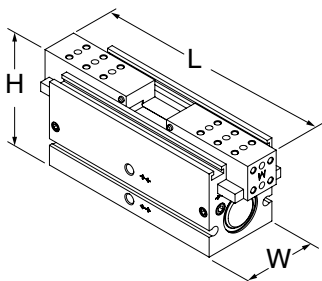

Size	L	W	H
10M-1	62 [2.44]	34.9 [1.37]	44.9 [1.77]
10M-2	86 [3.39]		
10M-3	113 [4.45]		
10M-4	137 [5.39]		



CLICK OR SCAN
To view full
catalog pages
on this product

Technical Data

Specifications	Units	10M-1	10M-2	10M-3	10M-4
Total Rated Grip Force F @ 100 psi [7 bar]	N [lbs]	222 [50]			
Total Stroke	mm [in]	6.4 [0.25]	12.7 [0.50]	19.1 [0.75]	25.4 [1.00]
Weight	kg [lbs]	0.17 [0.39]	0.24 [0.53]	0.68 [0.30]	0.81 [0.36]
Pressure Range (without spring)	bar [psi]	3-7 [40-100]			
Pressure Range (with spring)	bar [psi]	1.4-7 [20-100]		3.4-7 [50-100]	
Displacement	cm ³ [in ³]	1.2 [0.076]	2.5 [0.153]	3.8 [0.230]	5.0 [0.306]
Temperature Range (Buna-N seals)	°C [°F]	-35°~80° [-30°~180°]			
Temperature Range (Viton® seals)	°C [°F]	-30°~150° [-20°~300°]			
Actuation	sec	0.13	0.19	0.29	0.40

Accessories

Sensor Accessories	Model Numbers	Part Number	Qty/Unit
Inductive Sensor Mounting Kit (Mounts 2 Sensors)	All Models	OSMK-097	1-2
NPN Inductive Sensor with Qk. Disconnect*	All Models	OISN-019	1-4
PNP Inductive Sensor with Qk. Disconnect*	All Models	OISP-019	1-4
NPN Magneto Resistive Sensor w/Qk. Disconnect*	All Models	OHSN-017	1-4
PNP Magneto Resistive Sensor w/Qk. Disconnect*	All Models	OHSP-017	1-4
NPN Magneto Resistive Sensor (90°) w/Qk. Disconnect*	All Models	OHSN-011	1-4
PNP Magneto Resistive Sensor (90°) w/Qk. Disconnect*	All Models	OHSP-011	1-4
Quick Disconnect Cable (2 meters long)*	All Models	CABL-010	1-4
Quick Disconnect Cable (5 meters long)*	All Models	CABL-013	1-4
Quick Disconnect Cable Extension Cord (1 meter long)*	All Models	CABL-015	1-4
Quick Disconnect Cable Extension Cord (2 meters long)*	All Models	CABL-016	1-4
Pneumatic Accessories	Model Numbers	Part Number	Qty/Unit
Buna-N Seal Repair Kit	All Models	SLKT-183	1
Viton® Seal Repair Kit	All Models	SLKT-183V	1
-T Plumbing Fitting - M3 male to 3mm OD Tube Push-in Style	All Models	PLFT-021	1-2
-T Plumbing Fitting - M3 male to 2mm ID Tube Barb Style	All Models	PLFT-022	1-2
Fail Safe Valve - M5 (Metric)	All Models	OFSV-004	1
Adjustable Flow Control (Metric)	All Models	VLVF-008	1-2
Top Port Manifold Seal Kit	All Models	SLKT-184V	1

*Sensor and cable sold separately.

RDH SERIES

2-Jaw General Industrial Grippers

CLICK OR SCAN

To view full catalog pages on this product



How To Order

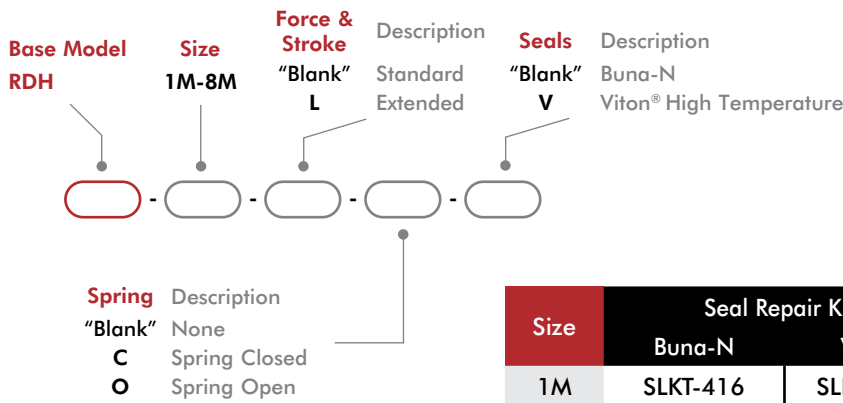
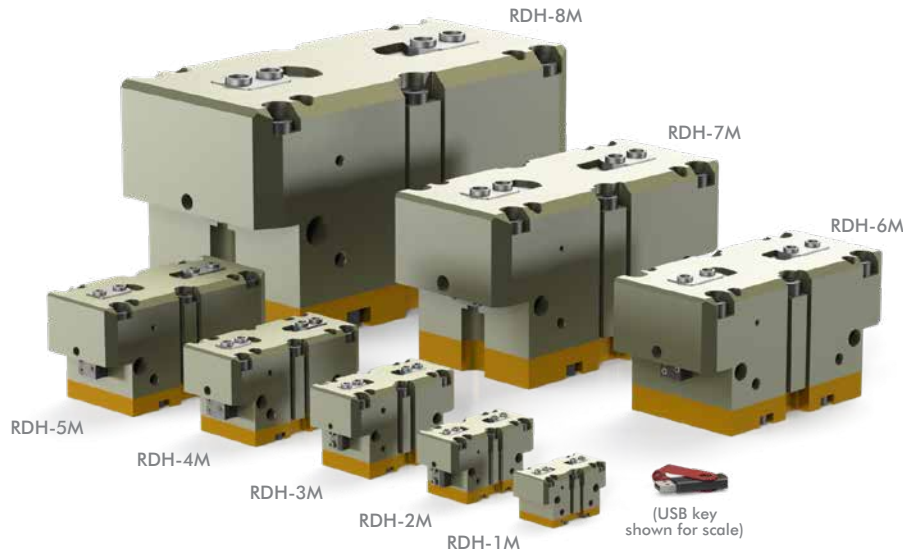

Size	Seal Repair Kits		Rear Inlet Seal Repair Kit	
	Buna-N	Viton®	Buna-N	Viton®
1M	SLKT-416	SLKT-416V	SLKT-363	SLKT-363V
2M	SLKT-417	SLKT-417V		
3M	SLKT-418	SLKT-418V	SLKT-364	SLKT-364V
4M	SLKT-419	SLKT-419V		
5M	SLKT-420	SLKT-420V	SLKT-365	SLKT-365V
6M	SLKT-421	SLKT-421V		
7M	SLKT-422	SLKT-422V		
8M	SLKT-423	SLKT-423V	SLKT-366	SLKT-366V

Basic Unit Dimensions

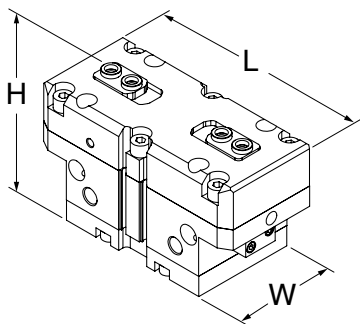

Size	L	W	H
1M	63 [2.48]	33 [1.30]	38.5 [1.52]
2M	83 [3.27]	40 [1.57]	58 [2.28]
3M	104 [4.09]	50 [1.97]	66 [2.60]
4M	129 [5.08]	60 [2.36]	74.5 [2.93]
5M	162 [6.38]	76 [2.99]	90.5 [3.56]
6M	205 [8.07]	100 [3.94]	113 [4.45]
7M	258 [10.16]	120 [4.72]	147 [5.79]
8M	355 [13.98]	180 [7.09]	201 [7.91]

**CLICK OR SCAN**

To view full catalog pages on this product

RDH SERIES

2-Jaw General Industrial Grippers

Specifications	Units	1M	1M-L	2M	2M-L	3M	3M-L	4M	4M-L
Total Rated Grip Force F @ 100 psi [7 bar] w/o Spring Assist	N [lbs]	555 [125]	361 [81]	754 [170]	494 [111]	1317 [296]	854 [192]	2177 [490]	1414 [318]
Total Rated Grip Force F @ 100 psi [7 bar] with Spring Assist	N [lbs]	693 [156]	452 [102]	1006 [226]	661 [149]	1683 [379]	1094 [246]	2789 [628]	1814 [408]
Total Stroke	mm [in]	4 [0.16]	8 [0.32]	6 [0.24]	12 [0.47]	8 [0.31]	16 [0.63]	10 [0.39]	20 [0.79]
Weight	kg [lbs]	0.19 [0.4]	0.21 [0.5]	0.39 [0.86]	0.42 [0.93]	0.82 [1.81]	0.88 [1.94]	1.43 [3.15]	1.51 [3.33]
Pressure Range	bar [psi]	w/spring 2-7 [30-100], w/o spring 3.5-7 [50-100]							
Max. Vacuum for Scavenge Port	mm Hg [in Hg]	200 [8]							
Max. Pressure for Purge Port	bar [psi]	2.1 [30]							
Displacement	cm ³ [in ³]	5 [0.31]		10.3 [0.63]		23.4 [1.43]		47.5 [2.90]	
Temperature Range (Buna-N seals)	°C [°F]	-35°~80° [-30°~180°]							
Temperature Range (Viton® seals)	°C [°F]	-30°~150° [-20°~300°]							
Actuation (open/close)	sec.	0.06		0.07		0.08			

Specifications (cont.)	Units	5M	5M-L	6M	6M-L	7M	7M-L	8M	8M-L
Total Rated Grip Force F @ 100 psi [7 bar] w/o Spring Assist	N [lbs]	3593 [808]	2333 [525]	6250 [1406]	4062 [914]	9901 [2228]	6404 [1441]	21958 [4941]	14178 [3190]
Total Rated Grip Force F @ 100 psi [7 bar] with Spring Assist	N [lbs]	4609 [1037]	2999 [675]	8640 [1944]	5623 [1265]	12542 [2822]	8135 [1830]	28002 [6300]	18115 [4076]
Total Stroke	mm [in]	13 [0.51]	26 [1.02]	16 [0.63]	32 [1.26]	25 [0.98]	50 [1.97]	35 [1.38]	70 [2.76]
Weight	kg [lbs]	2.75 [6.06]	2.98 [6.57]	5.77 [12.72]		11.25 [24.8]		32.3 [71.1]	
Pressure Range	bar [psi]	w/spring 2-7 [30-100], w/o spring 3.5-7 [50-100]							
Max. Vacuum for Scavenge Port	mm Hg [in Hg]	20 [8]							
Max. Pressure for Purge Port	bar [psi]	2.1 [30]							
Displacement	cm ³ [in ³]	102 [6.22]		216 [13.18]		540 [32.95]		1689 [103.1]	
Temperature Range (Buna-N seals)	°C [°F]	-35°~80° [-30°~180°]							
Temperature Range (Viton® seals)	°C [°F]	-30°~150° [-20°~300°]							
Actuation (open/close)	sec.	0.14		0.20		0.55		1.3	

Accessories

Sensor Accessories	Model Numbers	Part Number	Qty/Unit
8mm PNP Magneto Resistive Sensor (90° barrel) w/ M8 Qk. Disc*	All Models	OHSP-011	1-4
8mm NPN Magneto Resistive Sensor (90° barrel) w/ M8 Qk. Disc*	All Models	OHSN-011	1-4
8mm PNP Magneto Resistive Sensor Short Barrel w/ M8 Qk Disc*	All Models	OHSP-017	1-4
8mm NPN Magneto Resistive Sensor Short Barrel w/ M8 Qk Disc*	All Models	OHSN-017	1-4
8mm PNP Inductive Sensor w/ M12 Quick Disconnect*	RDH-4M, -5M, -6M	OISP-011	1-2
8mm NPN Inductive Sensor w/ M12 Quick Disconnect*	RDH-4M, -5M, -6M	OISN-011	1-2
12mm PNP Inductive Sensor w/ M12 Quick Disconnect*	RDH-7M, -8M	OISP-017	1-2
12mm NPN Inductive Sensor w/ M12 Quick Disconnect*	RDH-7M, -8M	OISN-017	1-2
M8 Quick Disconnect 2 Meter Cable Length*	All Models	CABL-010	1-4
M8 Quick Disconnect 5 Meter Cable Length*	All Models	CABL-013	1-4
M12 Quick Disconnect 2 Meter Cable Length*	RDH-7M, -8M	CABL-014	1-2
M12 Quick Disconnect 5 Meter Cable Length*	RDH-7M, -8M	CABL-018	1-2

Pneumatic Accessories	Model Numbers	Part Number	Qty/Unit
M5 Adjustable Flow Control	RDH-1M, -2M, -3M	VLVF-008	1-2
G 1/4" Adjustable Flow Control	RDH-4M, -5M, -6M, -7M	VLVF-005	1-2
G 1/8" Adjustable Flow Control	RDH-8M	VLVF-010	1-2

* Sensor and cable sold separately.

Dimensions and technical information are subject to change without notice

REP2 SERIES

2-Jaw General Industrial Grippers

How To Order

CLICK OR SCAN

To view full catalog pages on this product



(USB key shown for scale)

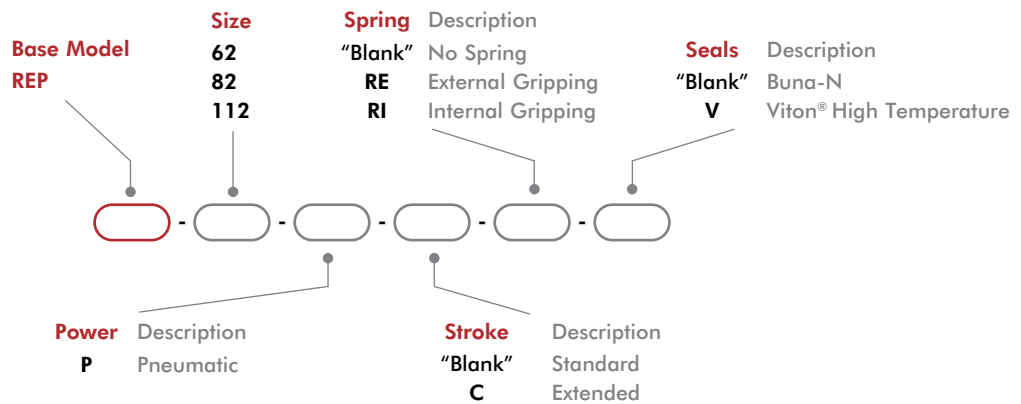

Size	Seal Repair Kits	
	Buna-N	Viton®
62P	SLKT-155	SLKT-155V
82P	SLKT-157	SLKT-157V
112P	SLKT-158	SLKT-158V



CLICK OR SCAN

To view full
catalog pages
on this product

REP2 SERIES

2-Jaw General Industrial Grippers

Basic Unit Dimensions

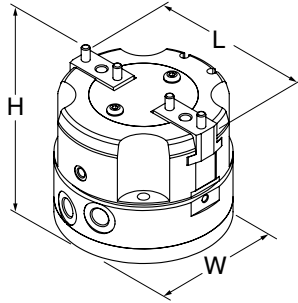

Size	L	W	H
62P	70	60 [2.36]	72 [2.83]
62P-C	82		
82P	94	80 [3.15]	74 [2.91]
82P-C	108		
112P	138	110 [4.33]	98 [3.86]
112P-C	158		

Technical Data

Specifications	Units	62	62-C	82	82-C	112	112-C
Total Rated Grip Force F @ 100 psi [7 bar]*	N [lbs]	771 [173]	480 [108]	2140 [481]	1382 [311]	3351 [753]	2233 [502]
Total Stroke	mm [in]	10 [0.394]	16 [0.630]	13 [0.512]	20 [0.787]	20 [0.787]	30 [1.181]
Weight	kg [lbs]	0.55 [1.2]		0.9 [2.0]		2.45 [5.4]	
Pressure Range w/o Spring	bar [psi]	2-7 [30-100]					
Pressure Range with Spring	bar [psi]	3-7 [45-100]		4-7 [60-100]			
Displacement	cm ³ [in ³]	12 [0.72]		35 [2.13]		87 [5.31]	
Temperature Range (Buna-N seals)	°C [°F]	-35°~80° [-30°~180°]					
Temperature Range (Viton® seals)	°C [°F]	-30°~150° [-20°~300°]					
Actuation (open/close)	sec	0.10		0.18		0.35	
Accuracy	mm [in]	±0.05 [±0.002]					

* with springs

Accessories

Sensor Accessories	Model Numbers	Part Number	Qty/Unit
NPN Inductive Sensor with M8 Quick Disconnect*	All Models	OISN-011	1-4
PNP Inductive Sensor with M8 Quick Disconnect*	All Models	OISP-011	1-4
NPN Magneto Resistive Sensor with Quick Disconnect*†	All Models	OHSN-006	1-2
PNP Magneto Resistive Sensor with Quick Disconnect*†	All Models	OHSP-006	1-2
NPN Magneto Resistive Sensor (Short Barrel) with Qk Disconnect*†	All Models	OHSN-017	1-2
PNP Magneto Resistive Sensor (Short Barrel) with Qk Disconnect*†	All Models	OHSP-017	1-2
M8 Quick Disconnect 2 Meter Cable Length*	All Models	CABL-010	1-4
M8 Quick Disconnect 2 Meter Cable Length*	All Models	CABL-013	1-4
Inductive Sensor Mounting Kit (Mounts 2 Sensors)	62	OSMK-102	1-2
Inductive Sensor Mounting Kit (Mounts 2 Sensors)	82	OSMK-103	1-2
Inductive Sensor Mounting Kit (Mounts 2 Sensors)	112	OSMK-104	1-2

* Sensor and cable sold separately. †The gripper comes with adjustable slots for two magnetic sensors (to control jaw position). Must be used with the -RE or -RI option.

RP5-10 SERIES

2-Jaw General Industrial Grippers

How To Order

CLICK OR SCAN

To view full catalog pages on this product

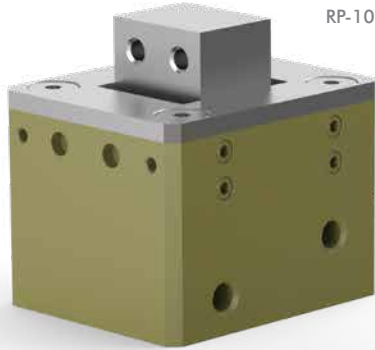

RP-10



RP-5, 5-FS

U.S. Patent #5,125,708



(USB key shown for scale)

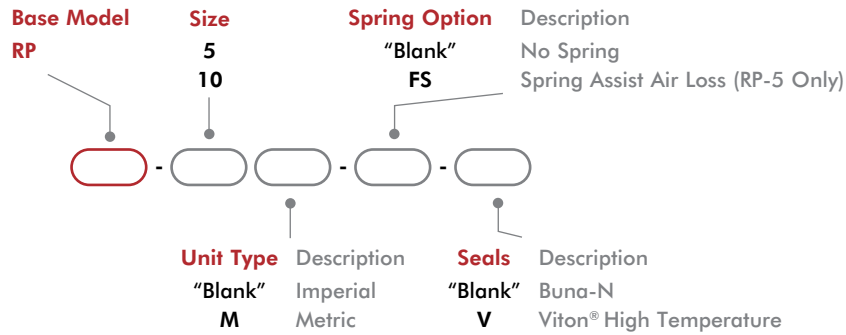

Size	Seal Repair Kits	
	Buna-N	Viton®
5	SLKT-152	SLKT-152V
10	SLKT-136	SLKT-136V



CLICK OR SCAN
To view full
catalog pages
on this product

RP5-10 SERIES

2-Jaw General Industrial Grippers

Basic Unit Dimensions

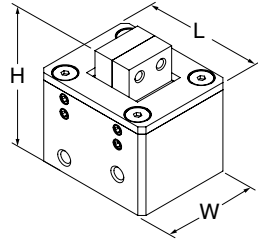

Size	L	W	H
5			
5-FS	29 [1.14]	25.4 [1.00]	36.5 [1.44]
10	38.1 [1.50]	31.7 [1.25]	37.3 [1.47]

Technical Data

Specifications	Units	5	5-FS	10
Total Rated Grip Force F @ 100 psi [7 bar]	N [lbs]	156 [35]	178 [40]	
Total Stroke	mm [in]	4.1 [0.16]		6.4 [0.25]
Weight	kg [lbs]	0.08 [0.18]		0.13 [0.28]
Pressure Range	bar [psi]	3-7 [40-100]		
Ingress Protection Class (IP)		IP43		
Displacement	cm ³ [in ³]	0.7 [0.042]		1.6 [0.098]
Temperature Range (Buna-N seals)	°C [°F]	-35°~80° [-30°~180°]		
Temperature Range (Viton® seals)	°C [°F]	-30°~150° [-20°~300°]		
Actuation	sec	0.14		0.13
Accuracy	mm [in]	±0.03 [±0.001]		
Repeatability	mm [in]	±0.01 [±0.0005]		
Valve to Actuate		4-way, 2-position		

Accessories

Sensor Accessories	Model Numbers	Part Number	Qty/Unit
Sensor Mounting Kit for Imperial & Metric Units (mounts 2 sensors)	RP-5	OSMK-001	1
Sensor Mounting Kit for Imperial & Metric Units (mounts 2 sensors)	RP-10	OSMK-002	1
NPN Inductive Sensor with Quick Disconnect*	All Models	OISN-019	1-2
PNP Inductive Sensor with Quick Disconnect*	All Models	OISP-019	1-2
Quick Disconnect 2 Meter Cable Length*	All Models	CABL-010	1-2
Quick Disconnect 5 Meter Cable Length*	All Models	CABL-013	1-2

Pneumatic Accessories	Model Numbers	Part Number	Qty/Unit
Fail Safe Valve (Imperial)	All Models	OFSV-001	1
Fail Safe Valve (Metric)	All Models	OFSV-004	1

* Sensor and cable sold separately.

RP SERIES

2-Jaw General Industrial Grippers

CLICK OR SCAN

To view full catalog pages on this product



How To Order

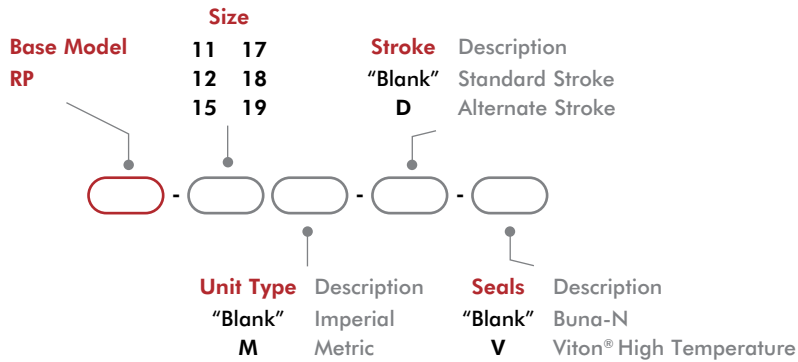
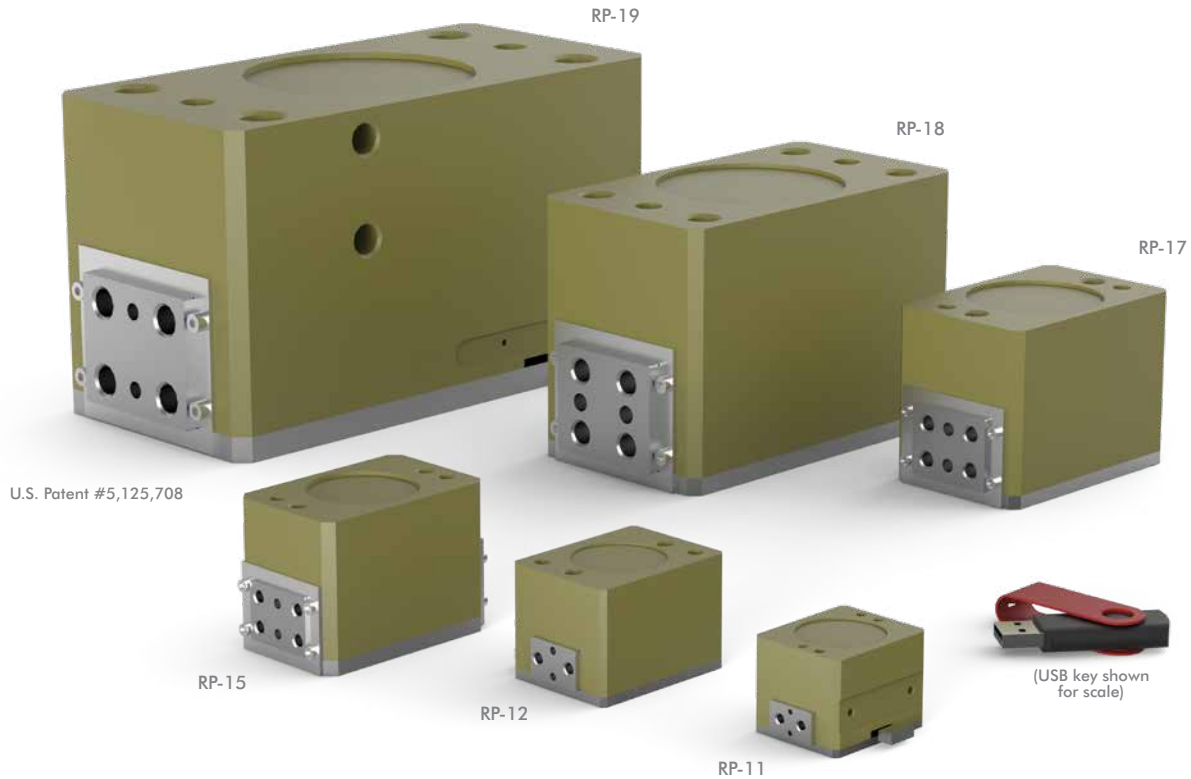

Size	Seal Repair Kits		Fail Safe Valve		Inductive Sensor Mtg Kit (mounts 2 sensors)
	Buna-N	Viton®	Imperial	Metric	
11	SLKT-036	SLKT-036V			
12	SLKT-040	SLKT-040V	OFSV-001	OFSV-004	OSMK-003
15	SLKT-041	SLKT-041V			
17	SLKT-042	SLKT-042V			
18	SLKT-043	SLKT-043V	OFSV-002	OFSV-005	OSMK-072
19	SLKT-044	SLKT-044V	OFSV-003	OFSV-006	OSMK-073



CLICK OR SCAN
To view full
catalog pages
on this product

Basic Unit Dimensions

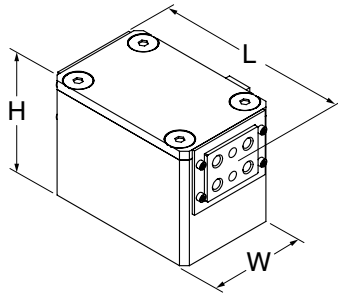

Size	L	L-D	W	H
11	48 [1.89]	45 [1.77]	31.8 [1.25]	28.6 [1.13]
12	63 [2.48]	60 [2.36]		35.6 [1.40]
15	81 [3.19]	76 [2.99]	41.3 [1.63]	47.3 [1.86]
17	108 [4.25]	117 [4.61]	54 [2.13]	61.9 [2.44]
18	177 [6.97]	190 [7.48]	74.9 [2.95]	92.8 [3.65]
19	266 [10.47]	254 [10.00]	100.3 [3.95]	118.7 [4.67]

Technical Data

Specifications	Units	11	11-D	12	12-D	15	15-D
Total Rated Grip Force F @ 100 psi [7 bar]	N [lbs]	178 [40]	312 [70]	178 [40]	267 [60]	310 [70]	445 [100]
Total Stroke	mm [in]	6.4 [0.25]	4 [0.16]	9.5 [0.38]	6 [0.24]	12.7 [0.50]	8 [0.31]
Weight	kg [lbs]	0.12 [0.26]		0.25 [0.56]		0.57 [1.25]	
Pressure Range	bar [psi]	3-7 [40-100]					
Displacement	cm ³ [in ³]	1.6 [0.098]		2.5 [0.150]		4.9 [0.300]	
Temperature Range (Buna-N seals)	°C [°F]	-35°~80° [-30°~180°]					
Temperature Range (Viton® seals)	°C [°F]	-30°~150° [-20°~300°]					
Actuation	sec	0.13				0.20	

Specifications	Units	17	17-D	18	18-D	19	19-D
Total Rated Grip Force F @ 100 psi [7 bar]	N [lbs]	979 [220]	578 [130]	1779 [400]	1112 [250]	2669 [600]	3336 [750]
Total Stroke	mm [in]	19.1 [0.75]	28 [1.10]	31.8 [1.25]	43 [1.70]	50.8 [2.00]	38.1 [1.50]
Weight	kg [lbs]	1.0 [2.2]		3.5 [7.7]		9.5 [21]	
Pressure Range	bar [psi]	3-7 [40-100]					
Displacement	cm ³ [in ³]	22.9 [1.400]		72.1 [4.400]		157.3 [9.600]	
Temperature Range (Buna-N seals)	°C [°F]	-35°~80° [-30°~180°]					
Temperature Range (Viton® seals)	°C [°F]	-30°~150° [-20°~300°]					
Actuation	sec	0.18		0.22		0.50	

Accessories

Sensor Accessories	Model Numbers	Part Number	Qty/Unit
Sensor Mounting Kit for Imperial & Metric Units (mounts 2 sensors)	See Datasheet		1
NPN Inductive Sensor with Quick Disconnect*	11, 12, 15	OISN-019	1-2
PNP Inductive Sensor with Quick Disconnect*	11, 12, 15	OISP-019	1-2
NPN Inductive Sensor with Quick Disconnect*	17, 18, 19	OISN-011	1-2
PNP Inductive Sensor with Quick Disconnect*	17, 18, 19	OISP-011	1-2
Quick Disconnect 2 Meter Cable Length*	All Models	CABL-010	1-2
Quick Disconnect 5 Meter Cable Length*	All Models	CABL-013	1-2

Pneumatic Accessories	Model Numbers	Part Number	Qty/Unit
Fail Safe Valve (Imperial)	See Datasheet		1
Fail Safe Valve (Metric)	See Datasheet		1

*Sensor and cable sold separately.

RPM/RPMC SERIES

2-Jaw General Industrial Grippers

How To Order

CLICK OR SCAN

To view full catalog pages on this product

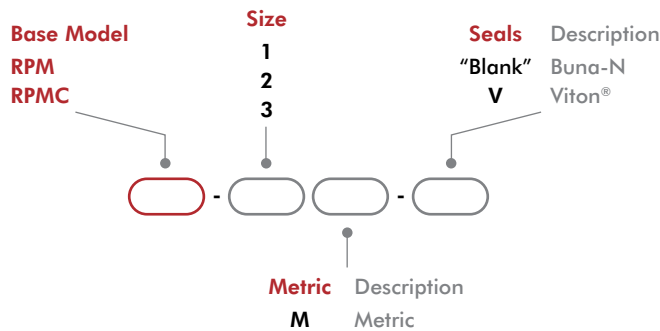

Basic Unit Dimensions

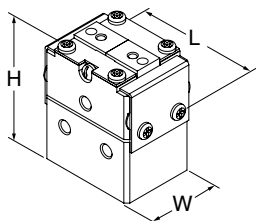

Size	L	W	H
1	23 [0.91]	16 [0.63]	24 [0.94]
2	24 [0.94]		25.5 [1.00]
3	30 [1.18]		

**CLICK OR SCAN**

To view full catalog pages on this product

RPM/RPMC SERIES

2-Jaw General Industrial Grippers

Technical Data

Specifications	Units	1	2	3
Total Rated Grip Force F @ 100 psi [7 bar]	N [lbs]	36 [8]		
Total Stroke	mm [in]	3.2 [0.13]	4.8 [0.19]	6.3 [0.25]
Weight	kg [lbs]	0.024 [0.052]	0.026 [0.058]	0.034 [0.074]
Pressure Range	bar [psi]	3-7 [40-100]		
Displacement	cm ³ [in ³]	0.13 [0.008]	0.20 [0.012]	0.25 [0.015]
Temperature Range (Buna-N seals)	°C [°F]	-35°~80° [-30°~180°]		
Temperature Range (Viton® seals)	°C [°F]	-30°~120° [-20°~250°]		
Actuation (open/close)	sec	0.10		

Accessories

Pneumatic Accessories	Model Numbers	Part Number	Qty/Unit
M3 Plumbing Fitting Push-in for 3mm O.D. Tube	All Models	PLFT-021	2
M3 Plumbing Fitting Barb for 2mm I.D. Tube	All Models	PLFT-022	2
Buna-N Seal Repair Kit	All Models	SLKT-121	1
Viton® Seal Repair Kit	All Models	SLKT-121V	1
Top Air Ports Manifold Seal Kit (available in Viton® only)	All Models (RPM)	SLKT-142V	1
Top Air Ports Manifold Seal Kit (available in Viton® only)	All Models (RPMC)	SLKT-143V	1

RPS SERIES

2-Jaw General Industrial Grippers

CLICK OR SCAN

To view full catalog pages on this product



How To Order

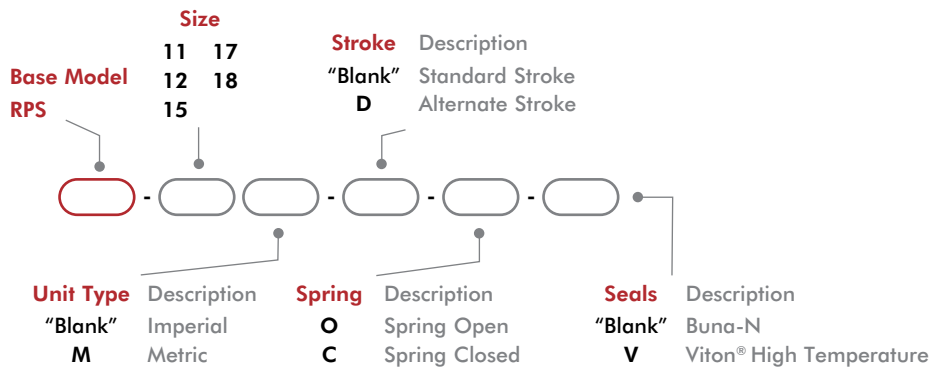

Size	Seal Repair Kits		Fail Safe Valve		Inductive Sensor Mtg Kit (mounts 2 sensors)
	Buna-N	Viton®	Imperial	Metric	
11	SLKT-036	SLKT-036V			
12	SLKT-040	SLKT-040V	OFSV-001	OFSV-004	OSMK-003
15	SLKT-041	SLKT-041V			
17	SLKT-042	SLKT-042V			
18	SLKT-043	SLKT-043V	OFSV-002	OFSV-005	OSMK-072



CLICK OR SCAN
To view full
catalog pages
on this product

RPS SERIES

2-Jaw General Industrial Grippers

Basic Unit Dimensions

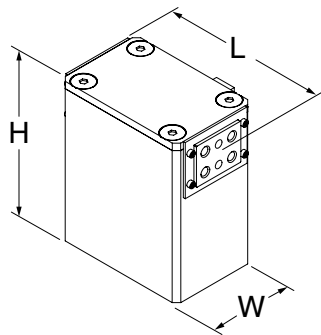

Size	L	W	H
11	48 [1.88]	31.8 [1.25]	44.1 [1.74]
11D	45 [1.79]		
12	63 [2.50]	41.3 [1.63]	51.2 [2.02]
12D	60 [2.37]		
15	81 [3.19]	54.0 [2.13]	71.6 [2.82]
15D	76 [3.00]		
17	107 [4.25]	74.9 [2.95]	98.7 [3.89]
17D	117 [4.60]		
18	177 [7.00]	154.4 [6.08]	
18D	190 [7.45]		

Technical Data

Specifications	Units	11	11-D	12	12-D	15	15-D
Total Rated Grip Force F @ 100 psi [7 bar]	N [lbs]	222 [50]	378 [85]	267 [60]	400 [90]	400 [90]	110 [489]
Total Stroke	mm [in]	6.4 [0.25]	4 [0.16]	9.5 [0.38]	6 [0.24]	12.7 [0.50]	8 [0.31]
Weight	kg [lbs]	0.16 [0.36]		0.34 [0.76]		0.65 [1.44]	
Pressure Range	bar [psi]	3.4-7 [50-100]					
Displacement	cm ³ [in ³]	1.6 [0.098]		2.5 [0.150]		4.9 [0.300]	
Temperature Range (Buna-N seals)	°C [°F]	-35°~80° [-30°~180°]					
Temperature Range (Viton® seals)	°C [°F]	-30°~150° [-20°~300°]					
Actuation	sec	0.15				0.17	

Specifications	Units	17	17-D	18	18-D
Total Rated Grip Force F @ 100 psi [7 bar]	N [lbs]	1334 [300]	180 [800]	2669 [600]	380 [1690]
Total Stroke	mm [in]	19.1 [0.75]	28 [1.10]	31.8 [1.25]	43 [1.70]
Weight	kg [lbs]	1.4 [3.00]		5.0 [11.02]	
Pressure Range	bar [psi]	3-7 [40-100]			
Displacement	cm ³ [in ³]	22.9 [1.400]		72.1 [4.400]	
Temperature Range (Buna-N seals)	°C [°F]	-35°~80° [-30°~180°]			
Temperature Range (Viton® seals)	°C [°F]	-30°~150° [-20°~300°]			
Actuation	sec	0.31		0.51	

Accessories

Sensor Accessories	Model Numbers	Part Number	Qty/Unit
Sensor Mounting Kit for Imperial & Metric Units (mounts 2 sensors)	See Datasheet		1
NPN Inductive Sensor with Quick Disconnect*	11, 12, 15	OISN-019	1-2
PNP Inductive Sensor with Quick Disconnect*	11, 12, 15	OISP-019	1-2
NPN Inductive Sensor with Quick Disconnect*	17, 18	OISN-011	1-2
PNP Inductive Sensor with Quick Disconnect*	17, 18	OISP-011	1-2
Quick Disconnect 2 Meter Cable Length*	All Models	CABL-010	1-2
Quick Disconnect 5 Meter Cable Length*	All Models	CABL-013	1-2
Pneumatic Accessories	Model Numbers	Part Number	Qty/Unit
Fail Safe Valves	See Datasheet		1

* Sensor and cable sold separately.

Dimensions and technical information are subject to change without notice

DPW SERIES

2-Jaw Heavy-Duty Parallel Grippers

CLICK OR SCAN

To view full catalog pages on this product



How To Order

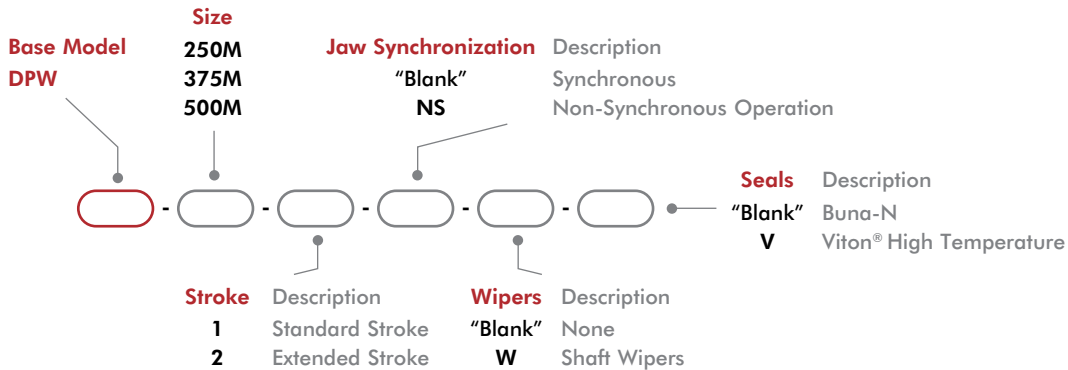
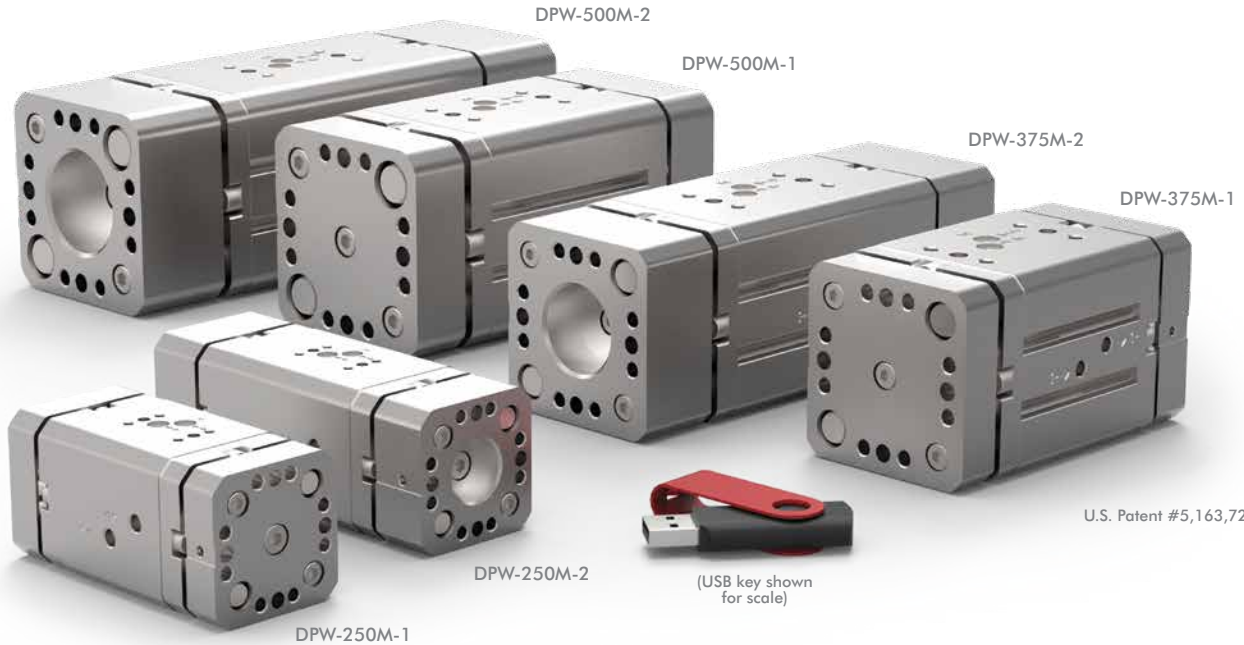

Size	Seal Repair Kits		Manifold Seal Kit Viton®	Shaft Wiper Seal Kit	Inductive Sensor Mtg Kit (3mm or 4mm)
	Buna-N	Viton®			
250M	SLKT-337	SLKT-337V	SLKT-197V	SLKT-338	OSMK-116
375M	SLKT-339	SLKT-339V	SLKT-199V	SLKT-340	OSMK-117
500M	SLKT-341	SLKT-341V		SLKT-342	OSMK-118

Basic Unit Dimensions

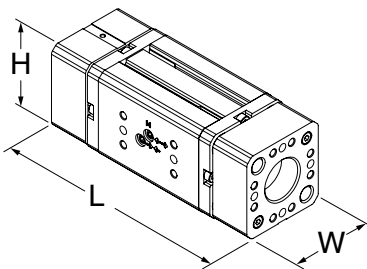

Size	L	W	H
250M-1	98 [3.86]	37.6 [1.48]	37.6 [1.48]
250M-2	136 [5.35]		
375M-1	122 [4.80]	54 [2.13]	54 [2.13]
375M-2	198 [7.80]		
500M-1	164 [6.46]	63 [2.48]	63 [2.48]
500M-2	240 [9.45]		



CLICK OR SCAN
To view full
catalog pages
on this product

DPW SERIES

2-Jaw Heavy-Duty Parallel Grippers

Technical Data

Specifications	Units	250M-1	250M-2	375M-1	375-2
Total Rated Grip Force F @ 100 psi	N [lbs]	222 [50]		445 [100]	
Total Stroke	mm [in]	19.1 [0.75]	31.8 [1.25]	25.4 [1.00]	50.8 [2.00]
Weight	kg [lbs]	0.30 [0.66]	0.39 [0.86]	0.81 [1.80]	1.20 [2.66]
Pressure Range	bar [psi]	1.5-7 [20-100]			
Displacement	cm ³ [in ³]	3.8 [0.023]	6.3 [0.383]	11.3 [0.690]	22.6 [1.382]
Temperature Range (Buna-N seals)	°C [°F]	-35°~80° [-30°~180°]			
Temperature Range (Viton® seals)	°C [°F]	-30°~150° [-20°~300°]			
Actuation	sec	0.12	0.14	0.16	0.20

Specifications	Units	500M-1	500M-2
Total Rated Grip Force F @ 100 psi	N [lbs]	800 [180]	
Total Stroke	mm [in]	38.1 [1.50]	63.5 [2.50]
Weight	kg [lbs]	1.48 [3.27]	2.0 [4.39]
Pressure Range	bar [psi]	1.5-7 [20-100]	
Displacement	cm ³ [in ³]	30.2 [1.841]	50.3 [3.068]
Temperature Range (Buna-N seals)	°C [°F]	-35°~80° [-30°~180°]	
Temperature Range (Viton® seals)	°C [°F]	-30°~150° [-20°~300°]	
Actuation	sec	0.20	0.28

Accessories

Sensor Accessories	Model Numbers	Part Number	Qty/Unit
PNP Magneto Resistive Sensor Short Barrel (with Qk. Disc.)*	All Models	OHSP-017	1-4†
NPN Magneto Resistive Sensor Short Barrel (with Qk. Disc.)*	All Models	OHSN-017	1-4†
PNP Magneto Resistive Sensor 90° Barrel (with Qk. Disc.)*	All Models	OHSP-011	1-4†
NPN Magneto Resistive Sensor 90° Barrel (with Qk. Disc.)*	All Models	OHSN-011	1-4†
PNP Inductive Sensor 3mm with Quick Disconnect*	All Models	OISP-019	1-2
NPN Inductive Sensor 3mm with Quick Disconnect.*	All Models	OISN-019	1-2
PNP Inductive Sensor 4mm with Quick Disconnect*	375M, 500M	OISP-014	1-2
NPN Inductive Sensor 4mm with Quick Disconnect*	375M, 500M	OISN-014	1-2
Quick Disconnect 2 Meter Cable Length*	All Models	CABL-010	1-4†
Quick Disconnect 5 Meter Cable Length*	All Models	CABL-013	1-4†

Pneumatic Accessories	Model Numbers	Part Number	Qty/Unit
Fail Safe Valve M5	All Models	OFSV-004	1
Adjustable Flow Control	All Models	VLVF-008	1-2

*Sensor and cable sold separately. †Except 250-1, 250-2, 1-2 only.

RPB SERIES

2-Jaw Heavy-Duty Parallel Grippers

CLICK OR SCAN

To view full catalog pages on this product



How To Order

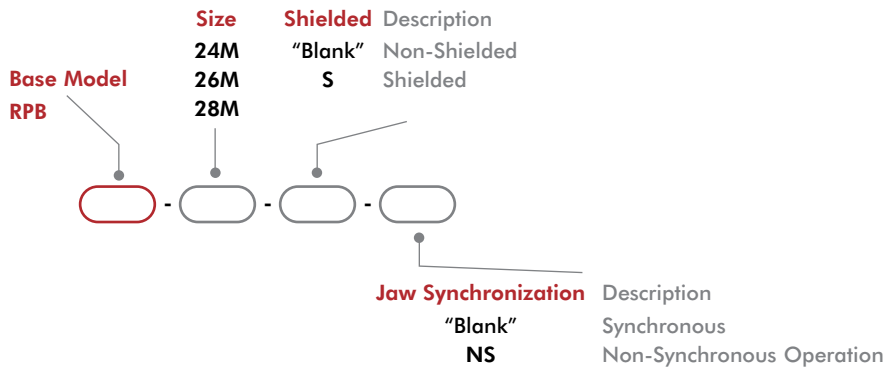

Size	Viton® Seal Repair Kits	Shield/Seal Repair Kit -S Only
24M		SLKT-152V
26M	SLKT-123V	SLKT-153V
28M		SLKT-166V

**CLICK OR SCAN**

To view full catalog pages on this product

RPB SERIES

2-Jaw Heavy-Duty Parallel Grippers

Basic Unit Dimensions

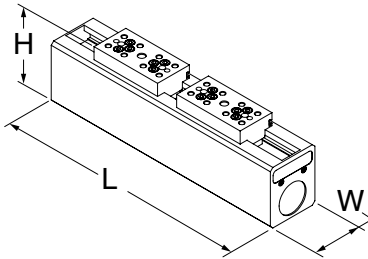

Size	L	W	H
250M	438.2 [17.25]	88.9 [3.50]	129 [5.08]
375M	590.5 [23.25]		
500M	734 [28.90]		

Technical Data

Specifications	Units	24M, 24M-S	26M, 26M-S	28M, 28M-S
Total Rated Grip Force F @ 100 psi [7 bar]	N [lbs]	2669 [600]		
Total Stroke	mm [in]	101.6 [4]	152.4 [6]	203.2 [8]
Weight	kg [lbs]	10.9 [24]	14.5 [32]	19.1 [42]
Pressure Range	bar [psi]	1.4-7 [20-100]		
Cylinder Bore \varnothing	mm [in]	50.8 [2.000]		
Displacement	cm ³ [in ³]	204.8 [12.5]	308.1 [18.8]	410 [25]
Temperature Range (Viton [®] seals)	°C [°F]	-30°~150° [-20°~300°]		
Actuation	sec	0.5	0.75	1.00

Accessories

Sensor Accessories	Model Numbers	Part Number	Qty/Unit
12mm Sensor Mounting Kit (mounts 2 sensors)	24, 26, 28	OSMK-078	1-2
12mm Sensor Mounting Kit (mounts 2 sensors)	24-S, 26-S, 28-S	OSMK-079	1-2
12mm PNP Inductive Sensor with Quick Disconnect*	All Models	OISP-017	1-4
12mm NPN Inductive Sensor with Quick Disconnect*	All Models	OISN-017	1-4
Quick Disconnect 2 Meter Cable Length*	All Models	CABL-014	1-4

Pneumatic Accessories	Model Numbers	Part Number	Qty/Unit
Fail Safe Valve (Metric)	All Models	OFSV-006	1

*Sensor and cable sold separately.

RPR SERIES

2-Jaw Heavy-Duty Parallel Grippers

CLICK OR SCAN

To view full catalog pages on this product



How To Order

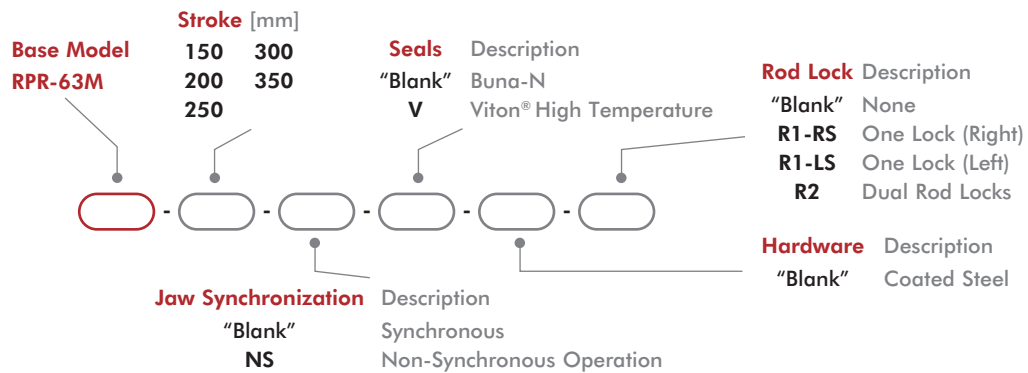
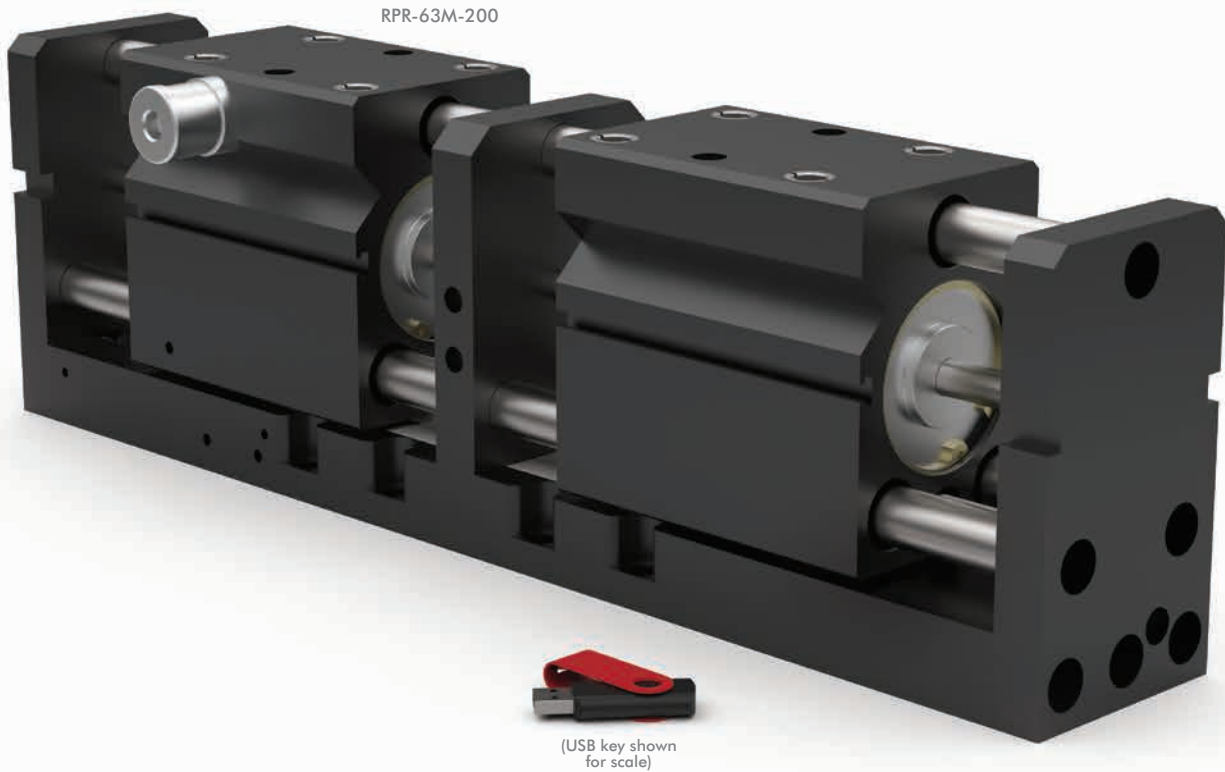



Basic Unit Dimensions

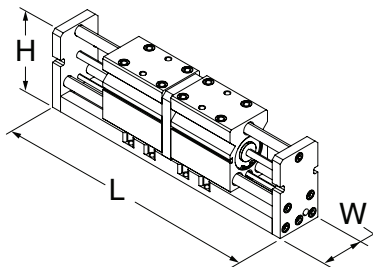

Size	L	W	H
150	489.8 [19.28]	88.9 [3.50]	161.9 [6.37]
200	539.8 [21.25]	88.9 [3.50]	161.9 [6.37]
250	589.8 [23.22]	88.9 [3.50]	161.9 [6.37]
300	639.8 [25.19]	88.9 [3.50]	161.9 [6.37]
350	689.8 [27.16]	88.9 [3.50]	161.9 [6.37]

Technical Data

Specifications	Units	RPR-63M-150	RPR-63M-200	RPR-63M-250	RPR-63M-300	RPR-63M-350
Total Rated Grip Force F @ 7 bar [100 psi]	N [lbs]	3250 [800]				
Total Stroke	mm [in]	150 [5.91]	200 [7.87]	250 [9.84]	300 [11.81]	350 [13.78]
Weight	kg [lbs]	13.6 [30]	15.8 [35]	18.1 [40]	20.4 [45]	22.7 [50]
Pressure Range	bar [psi]	3-7 [40-100]				
Displacement	cm ³ [in ³]	623 [38.2]				
Temperature Range (Buna-N seals)	°C [°F]	-35°~80° [-30°~180°]				
Temperature Range (Viton® seals)	°C [°F]	-30°~150° [-20°~300°]				
Actuation	sec	1.3				

Accessories

Sensor Accessories	Part Number	Qty/Unit
Sensor Mounting Kit for Imperial & Metric Units (mounts 2 sensors)	OSMK-131	1
12mm PNP Inductive Sensor with Quick Disconnect*	OISP-017	1-2
12mm NPN Inductive Sensor with Quick Disconnect*	OISN-017	1-2
Quick Disconnect 2 Meter Cable Length*	CABL-014	1-2
Quick Disconnect 5 Meter Cable Length*	CABL-018	1-2

Pneumatic Accessories	Part Number	Qty/Unit
Fail Safe Valve 1/4 BSPP	OFSV-006	1
Buna-N Seal Repair Kit	SLKT-452	1
Viton® Seal Repair Kit	SLKT-453	1

*Sensor and cable sold separately.

RPW SERIES

2-Jaw Heavy-Duty Parallel Grippers

CLICK OR SCAN

To view full catalog pages on this product



How To Order

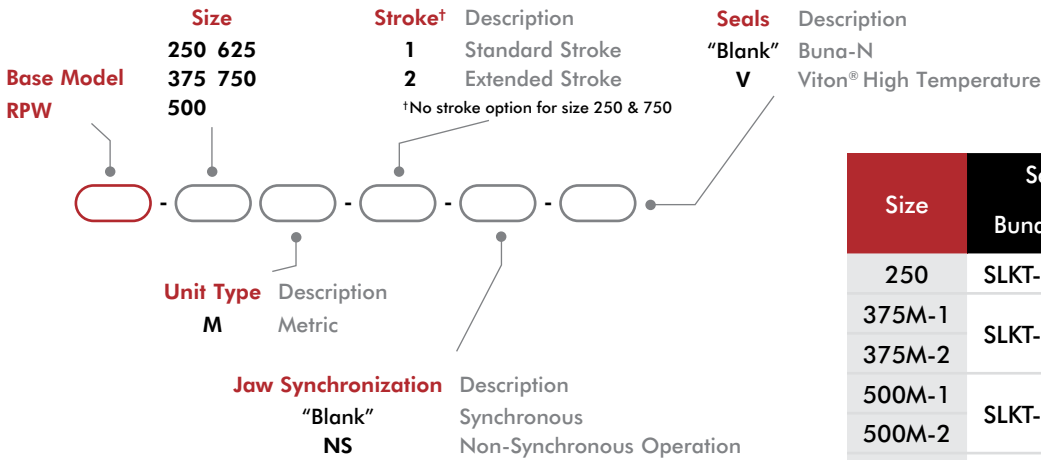

Size	Seal Repair Kits		Inductive Sensor Mtg Kit (2 Sensors)
	Buna-N	Viton®	
250	SLKT-055	SLKT-055V	OSMK-009
375M-1	SLKT-056	SLKT-056V	OSMK-010
375M-2			OSMK-011
500M-1	SLKT-058	SLKT-058V	OSMK-012
500M-2			OSMK-013
625M-1	SLKT-071	SLKT-071V	OSMK-074
625M-2			
750	SLKT-060	SLKT-060V	OSMK-014

Basic Unit Dimensions

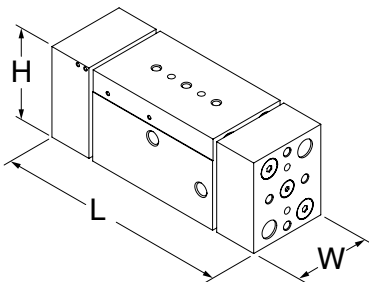

Size	L	W	H
250	93 [3.66]	31.5 [1.24]	40.9 [1.61]
375M-1	120 [4.72]	37.8 [1.49]	50.5 [1.99]
375M-2	187 [7.36]		
500M-1	171 [6.73]	56.9 [2.24]	66.4 [2.61]
500M-2	234 [9.21]		
625M-1	219 [8.62]	66.4 [2.61]	82.3 [3.24]
625M-2	321 [12.64]		
750	410 [16.14]	75 [2.95]	99.8 [3.93]

**CLICK OR SCAN**

To view full catalog pages on this product

RPW SERIES

2-Jaw Heavy-Duty Parallel Grippers

Specifications	Units	250	375-1	375M-2
Total Rated Grip Force F @ 100 psi	N [lbs]	222 [50]	400 [90]	
Total Stroke	mm [in]	19.1 [0.75]	25.4 [1.00]	50.8 [2.00]
Weight	kg [lbs]	0.30 [0.66]	0.59 [1.3]	0.91 [2.0]
Pressure Range	bar [psi]	3-7 [40-100]		
Displacement	cm ³ [in ³]	3.8 [0.023]	9.8 [0.600]	19.7 [1.200]
Temperature Range (Buna-N seals)	°C [°F]	-35°~80° [-30°~180°]		
Temperature Range (Viton® seals)	°C [°F]	-30°~150° [-20°~300°]		
Actuation	sec	0.16	0.20	0.25

Specifications	Units	500-1	500-2
Total Rated Grip Force F @ 100 psi	N [lbs]	667 [150]	
Total Stroke	mm [in]	38.1 [1.50]	63.5 [2.50]
Weight	kg [lbs]	1.4 [3.0]	1.85 [4.0]
Pressure Range	bar [psi]	3-7 [40-100]	
Displacement	cm ³ [in ³]	29.5 [1.800]	49.2 [3.000]
Temperature Range (Buna-N seals)	°C [°F]	-35°~80° [-30°~180°]	
Temperature Range (Viton® seals)	°C [°F]	-30°~150° [-20°~300°]	
Actuation	sec	0.25	0.33

Specifications	Units	625-1	625-2	750
Total Rated Grip Force F @ 100 psi	N [lbs]	1068 [240]		2091 [470]
Total Stroke	mm [in]	50.8 [2.00]	88.9 [3.50]	114.3 [4.50]
Weight	kg [lbs]	3.0 [6.5]	3.6 [7.8]	6.4 [14]
Pressure Range	bar [psi]	3-7 [40-100]		
Displacement	cm ³ [in ³]	21.6 [1.320]	37.9 [2.310]	232.7 [14.200]
Temperature Range (Buna-N seals)	°C [°F]	-35°~80° [-30°~180°]		
Temperature Range (Viton® seals)	°C [°F]	-30°~150° [-20°~300°]		
Actuation	sec	0.52	0.69	1.00

Accessories

Sensor Accessories	Model Numbers	Part Number	Qty/Unit
Sensor Mounting Kit for Imperial & Metric Units (mounts 2 sensors)	See Datasheet		1
PNP Inductive Sensor with Quick Disconnect*	250, 375, 500	OISP-014	1-2
NPN Inductive Sensor with Quick Disconnect*	250, 375, 500	OISN-014	1-2
PNP Inductive Sensor with Quick Disconnect*	625, 750	OISP-011	1-2
NPN Inductive Sensor with Quick Disconnect*	625, 750	OISN-011	1-2
Quick Disconnect 2 Meter Cable Length*	All Models	CABL-010	1-2
Quick Disconnect 5 Meter Cable Length*	All Models	CABL-013	1-2

Pneumatic Accessories	Model Numbers	Part Number	Qty/Unit
Fail Safe Valve (Imperial)	250, 375	OFSV-001	1
Fail Safe Valve (Metric)	250, 375	OFSV-004	1
Fail Safe Valve (Imperial)	500, 625, 750	OFSV-002	1
Fail Safe Valve (Metric)	500, 625, 750	OFSV-005	1

*Sensor and cable sold separately.

G110 SERIES

OEM Parallel Grippers

How To Order

CLICK OR SCAN

To view full catalog pages on this product



G120 Extended Jaw Option Shown

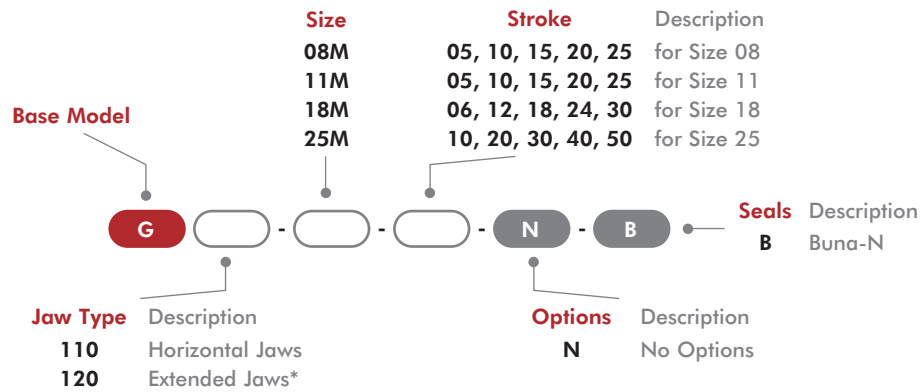

Basic Unit Dimensions

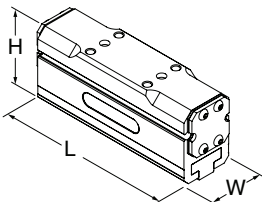

Size	L	W	H
G110-08M	43-103 [1.69-4.06]	20 [0.79]	28 [1.10]
G110-11M	43-103 [1.69-4.06]	24 [0.94]	36.5 [1.44]
G110-18M	54-125 [2.13-4.92]	30 [1.18]	43 [1.69]
G110-25M	73-193 [2.87-7.60]	40 [1.57]	61 [2.40]

**CLICK OR SCAN**

To view full catalog pages on this product

G110 SERIES

OEM Parallel Grippers

Technical Data

Specifications	Units	08M-05	08M-10	08M-15	08M-20	08M-25
Total Rated Grip Force	N [lbf]	56 [13]				
Stroke	mm [in]	5 [0.20]	10 [0.39]	15 [0.59]	20 [0.79]	25 [0.98]
Weight	kg [lbs]	0.06 [0.13]	0.09 [0.20]	0.11 [0.24]	0.14 [0.31]	0.17 [0.37]
Pressure Range	bar [psi]	3-7 [40-100]				
Displacement	cc [cu-in]	0.3 [0.02]	0.5 [0.03]	0.7 [0.05]	1.0 [0.06]	1.2 [0.08]
Cylinder Bore Diameter	mm [in]	8 [0.31]				
Temperature Range (Buna-N)	°C [°F]	-35°~80° [-30°~180°]				
Actuation (open/close)	sec.	0.06	0.07	0.08	0.09	0.10

Specifications	Units	11M-05	11M-10	11M-15	11M-20	11M-25
Total Rated Grip Force	N [lbf]	104 [23]				
Stroke	mm [in]	5 [0.20]	10 [0.39]	15 [0.59]	20 [0.79]	25 [0.98]
Weight	kg [lbs]	0.09 [0.20]	0.13 [0.29]	0.17 [0.37]	0.21 [0.46]	0.25 [0.55]
Pressure Range	bar [psi]	3-7 [40-100]				
Displacement	cc [cu-in]	0.5 [0.03]	1.0 [0.06]	1.5 [0.09]	1.9 [0.12]	1.2 [0.15]
Cylinder Bore Diameter	mm [in]	11 [0.44]				
Temperature Range (Buna-N)	°C [°F]	-35°~80° [-30°~180°]				
Actuation (open/close)	sec.	0.08	0.09	0.10	0.1	0.12

Specifications	Units	18M-06	18M-12	18M-18	18M-24	18M-30
Total Rated Grip Force	N [lbf]	260 [58]				
Stroke	mm [in]	6 [0.24]	12 [0.47]	18 [0.71]	24 [0.94]	25 [0.98]
Weight	kg [lbs]	0.20 [0.44]	0.22 [0.48]	0.28 [0.62]	0.34 [0.75]	0.41 [0.90]
Pressure Range	bar [psi]	3-7 [40-100]				
Displacement	cc [cu-in]	1.5 [0.09]	2.9 [0.18]	4.3 [0.26]	5.8 [0.35]	7.2 [0.44]
Cylinder Bore Diameter	mm [in]	17.5 [0.69]				
Temperature Range (Buna-N)	°C [°F]	-35°~80° [-30°~180°]				
Actuation (open/close)	sec.	0.09	0.13	0.17	0.21	0.25

Specifications	Units	25M-10	25M-20	25M-30	25M-40	25M-50
Total Rated Grip Force	N [lbf]	558 [125]				
Stroke	mm [in]	10 [0.39]	20 [0.79]	30 [1.18]	40 [1.57]	50 [1.97]
Weight	kg [lbs]	0.42 [0.92]	0.64 [1.41]	0.85 [1.87]	1.03 [2.27]	1.22 [2.68]
Pressure Range	bar [psi]	3-7 [40-100]				
Displacement	cc [cu-in]	5.06 [0.31]	10.12 [0.62]	15.19 [0.93]	20.3 [1.24]	25.31 [1.55]
Cylinder Bore Diameter	mm [in]	25 [1.00]				
Temperature Range (Buna-N)	°C [°F]	-35°~80° [-30°~180°]				
Actuation (open/close)	sec.	0.28	0.36	0.44	0.52	0.61

G110 SERIES

OEM Parallel Grippers

CLICK OR SCAN

To view full catalog pages on this product



Accessories

Sensor Accessories	Model Numbers	Part Number	Qty/Unit
Sensor, NPN magneto resistive type, 4mm Barrel	All Models	OHSN-021	1-4
Sensor, PNP magneto resistive type, 4mm Barrel	All Models	OHSP-021	1-4
Cable straight, quick disconnect, socket, 3 conductor, 2M length	All Models	CABL-010	1-4

*Sensor and cable sold separately.

Power, Seal and Finger Mounting Accessories	08M	11M	18M	25M	Qty/Unit
Pneumatic air fitting	PLFT-021		PLFT-041		2
Valve kit, failsafe	N/A		OFSV-004		1
Jaw locating sleeve for precise finger mounting	20961-11		20962-11	20963-11	4
Seal Kit (includes): End gasket (Qty 2) Seal: U-cup Buna replacement seal (Qty 4) Button head socket cap screws (Qty 8)	SLKT-244	SLKT-245	SLKT-246	SLKT-247	1

Commissioning Kits for Easy Ordering



2 Sensors



2 Air Fittings



4 Jaw Locating Finger Sleeves



4 Finger Mounting Screws

Commissioning Kits for:	Part Number
G110-08M, G120-08M	G110-QKST-101
G110-11M, G120-11M	G110-QKST-102
G110-18M, G120-18M	G110-QKST-103
G110-25M, G120-25M	G110-QKST-104

G120 Extended Jaw Option, Finger Interchangeability Table*

(G120 units ship with extended jaw option installed)



Extended Jaw Option Part Number	Mounts to G110 Series Part Number	Compatible with SMC Part Number
G110-FNGR-08M-05	G110-08M-05-N-B	MHZ2-10
G110-FNGR-08M-10	G110-08M-10-N-B	MHZL2-10
G110-FNGR-11M-05	G110-11M-05-N-B	MHZ2-16
G110-FNGR-11M-10	G110-11M-10-N-B	MHZL2-16
G110-FNGR-18M-12	G110-18M-12-N-B	MHZ2-25
G110-FNGR-18M-24	G110-18M-24-N-B	MHZL2-25
G110-FNGR-25M-20	G110-25M-20-N-B	MHZ2-32

*Verify acceptable stroke and force changes in the table above for your application. G120 units are shipped with the extended jaw option mounted from factory. SMC is a registered trademark of SMC Corporation.

A large grid of small squares, intended for taking notes. The grid consists of approximately 30 columns and 40 rows of squares, covering most of the page area.

3P SERIES

3-Jaw Parallel Grippers

CLICK OR SCAN

To view full catalog pages on this product



How To Order



Note: See catalog for complete options information.

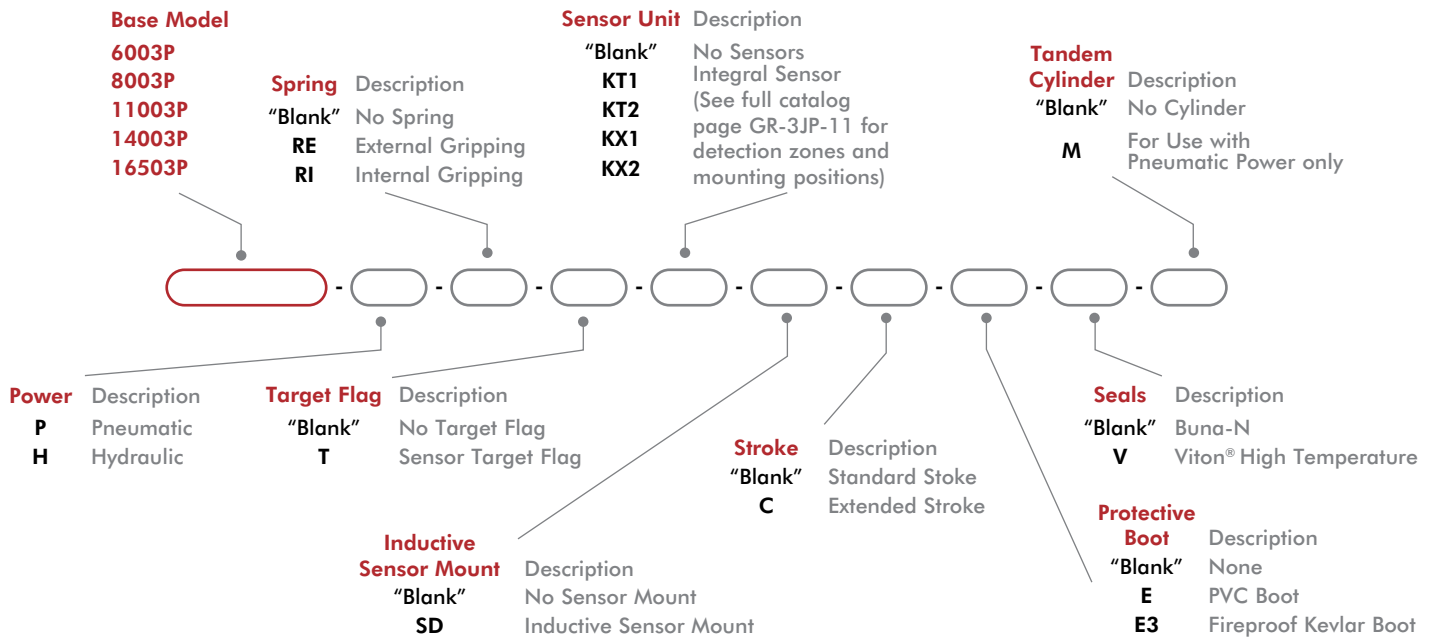

Size	Seal Repair Kits			Protective Boots	
	Buna-N	Viton®	Hydraulic	PVC - Brown or Black	Fireproof KEVLAR - Red
6003P	SLKT-156	SLKT-156V	SLKT-330	ER63P	E3R63P
8003P	S80	S80V	S80H	ER83P	E3R83P
11003P	S100	S110V	S110H	ER113P	E3R113P
14003P	SLKT-333	SLKT-333	SLKT-334	KP-317	KP-319
16503P	SLKT-335	SLKT-335V	SLKT-336	KP-320	KP-322

**CLICK OR SCAN**

To view full catalog pages on this product

3P SERIES

3-Jaw Parallel Grippers

Basic Unit Dimensions

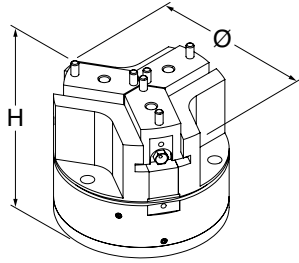

Size	Ø	Ø Max. C	H
6003P	72 [2.83]	78 [3.07]	77 [3.03]
8003P	91.6 [3.61]	98.4 [3.87]	78 [3.07]
11003P	126 [4.96]	136 [5.35]	106 [4.17]
14003P	165 [6.50]	179 [7.05]	137 [5.39]
16503P	194 [7.64]	204 [8.03]	169 [6.65]

Technical Data

Specifications	Units	6003P-P	6003P-P-C	8003P-P	8003P-P-C	11003P-P	11003P-P-C
Grip Force (F6+R)1, 6 bar [87 psi], Springs Mid-Way, L=0	N [lbs]	678 [152]	422 [95]	1888 [424]	1219 [274]	1979 [445]	2030 [456]
Grip Force (F0+R)2, 0 bars, Springs Mid-Way, L=0	N [lbs]	172 [39]	107 [24]	617 [139]	398 [89]	628 [141]	644 [145]
Total Stroke	mm [in]	10 [0.39]	16 [0.63]	13 [0.51]	20 [0.79]	20 [0.79]	30 [1.18]
Weight	kg [lbs]	0.60 [1.32]		0.97 [2.14]		2.35 [5.18]	
Pressure Range	bar [psi]	w/ Spring 4-7 [60-100] , w/o Spring 2-7 [30-100]					
Displacement	cm ³ [in ³]	12 [0.73]		35 [2.14]		87 [5.31]	
Temp. Range	°C [°F]	Buna-N -35°~80° [-30°~180°], Viton -30°~150° [-20°~300°]					
Actuation (open/close)	sec.	0.07		0.08		0.10	

Specifications	Units	14003P-P	14003P-P-C	16503P-P	16503P-P-C
Grip Force (F6+R)1, 6 bar [87 psi], Springs Mid-Way, L=0	N [lbs]	6077 [1366]	4031 [906]	11190 [2515]	6878 [1546]
Grip Force (F0+R)2, 0 bars, Springs Mid-Way, L=0	N [lbs]	2248 [508]	1490 [335]	3730 [838]	2292 [515]
Total Stroke	mm [in]	26 [1.02]	40 [1.57]	30 [1.18]	50 [1.97]
Weight	kg [lbs]	4.7 [10.36]		9.04 [19.92]	
Pressure Range	bar [psi]	w/ Spring 4-7 [60-100] , w/o Spring 2-7 [30-100]			
Displacement	cm ³ [in ³]	220 [13.43]		494 [30.15]	
Temp. Range	°C [°F]	Buna-N -35°~80° [-30°~180°], Viton -30°~150° [-20°~300°]			
Actuation (open/close)	sec.	0.16		0.29	

Accessories

Sensor Accessories	Model Numbers	Part Number	Qty/Unit
M8 Inductive Sensor PNP with M8 Connector	6003P, 8003P, 11003P	OISP-011	1-4
M8 Inductive Sensor NPN with M8 Connector	6003P, 8003P, 11003P	OISN-011	1-4
M8 Inductive Sensor PNP with M12 Connector	14003P, 16503P	OISP-017	1-4
M8 Inductive Sensor NPN with M12 Connector	14003P, 16503P	OISN-017	1-4
M8 Quick Disconnect 2 Meter Cable Length*	6003P, 8003P, 11003P	CABL-010	1-4
M12 Quick Disconnect 2 Meter Cable Length*	14003P, 16503P	CABL-014	1-4
Inductive Sensor Mounting Kit (1 holder, 1 flag, 2 spacers)	6003P, 8003P	SD60-80P	1-2
Inductive Sensor Mounting Kit (1 holder, 1 flag, 2 spacers)	11003P	SD110P	1-2
Inductive Sensor Mounting Kit (1 holder, 1 flag, 2 spacers)	14003P	OSMK-114	1-2
Inductive Sensor Mounting Kit (1 holder, 1 flag, 2 spacers)	16503P	OSMK-115	1-2

*Sensor and cable sold separately.

Dimensions and technical information are subject to change without notice

RTH SERIES

3-Jaw Parallel Grippers

CLICK OR SCAN

To view full catalog pages on this product



How To Order

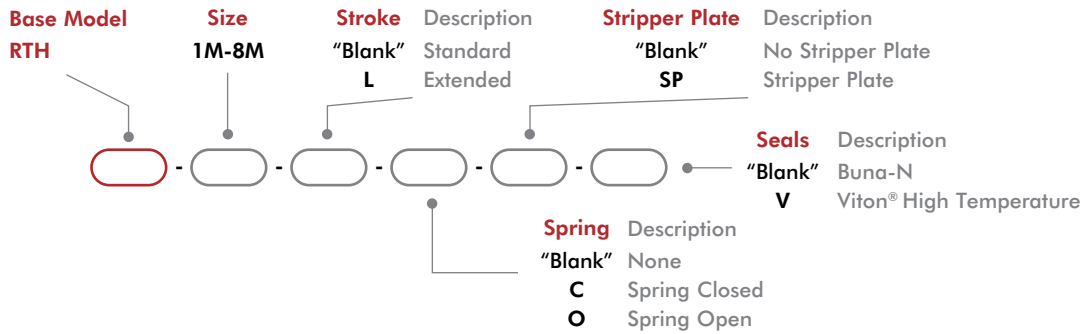
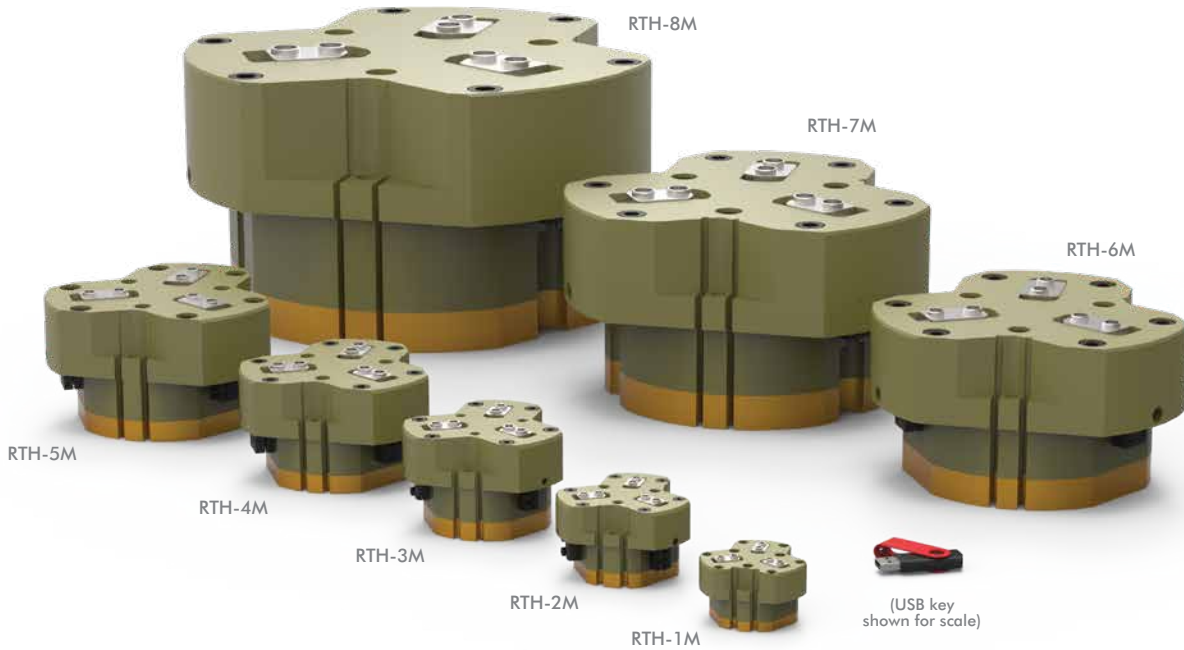

Size	Seal Repair Kits		Rear Inlet Seal Repair Kits	
	Buna-N	Viton®	Buna-N	Viton®
1M	SLKT-347	SLKT-347V	SLKT-363	SLKT-363V
2M	SLKT-348	SLKT-348V	SLKT-364	SLKT-364V
3M	SLKT-349	SLKT-349V	SLKT-365	SLKT-365V
4M	SLKT-350	SLKT-350V	SLKT-366	SLKT-366V

Size	Seal Repair Kits		Rear Inlet Seal Repair Kits	
	BunaN	Viton®	BunaN	Viton®
5M	SLKT351	SLKT351V	SLKT365	SLKT365V
6M	SLKT352	SLKT352V	SLKT366	SLKT366V
7M	SLKT353	SLKT353V		
8M	SLKT354	SLKT354V		

Basic Unit Dimensions

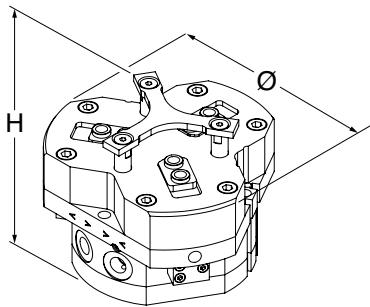

Size	Ø	H
1M	63 [2.48]	43 [1.69]
2M	83 [3.27]	57 [2.24]
3M	104 [4.09]	73.5 [2.89]
4M	129 [5.08]	88.5 [3.48]
5M	162 [6.38]	98.5 [3.88]
6M	205 [8.07]	121 [4.76]
7M	258 [10.16]	155 [6.10]
8M	355 [13.98]	209 [8.23]



CLICK OR SCAN
To view full
catalog pages
on this product

RTH SERIES

3-Jaw Parallel Grippers

Specifications	Units	1M	1M-L	2M	2M-L	3M	3M-L	4M	4M-L
Total Rated Grip Force F	N	682	443	1238	812	2078	1349	3644	2366
@ 100 psi [7 bar] w/o Spring Assist	[lbs]	[153]	[100]	[278]	[183]	[467]	[303]	[819]	[532]
Total Rated Grip Force F	N	889	579	1490	979	2627	1708	4562	2967
@ 100 psi [7 bar] with Spring Assist	[lbs]	[200]	[130]	[335]	[220]	[591]	[384]	[1026]	[667]
Total Stroke	mm	4	8	6	12	8	16	10	20
	[in]	[0.16]	[0.32]	[0.24]	[0.47]	[0.31]	[0.63]	[0.39]	[0.79]
Weight	kg [lbs]	0.25 [0.6]		1.2 [0.53]		1.08 [2.4]		1.95 [4.3]	
Pressure Range w/o Spring	bar [psi]	2-7 [30-100]							
Pressure Range with Spring	bar [psi]	4-7 [60-100]			3.5-7 [50-100]			3-7 [45-100]	
Max. Vacuum for Scavenge Port	mm Hg [in Hg]	200 [8]							
Max. Pressure for Purge Port	bar [psi]	2.1 [30]							
Displacement	cm ³ [in ³]	6.5 [0.40]		17 [1.05]		37 [2.30]		80 [4.90]	
Temperature Range	°C [°F]	Buna-N -35°~80° [-30°~180°], Viton -30°~150° [-20°~300°]							
Actuation (open/close)	sec.	0.06		0.07		0.08		0.1	

Specifications (cont.)	Units	5M	5M-L	6M	6M-L	7M	7M-L	8M	8M-L
Total Rated Grip Force F	N	6353	4125	10202	6629	17165	11102	35288	22784
@ 100 psi [7 bar] w/o Spring Assist	[lbs]	[1428]	[927]	[2294]	[1490]	[3859]	[2496]	[7933]	[5122]
Total Rated Grip Force F	N	7877	5124	13786	8971	22093	14322	44354	28690
@ 100 psi [7 bar] with Spring Assist	[lbs]	[1771]	[1152]	[3099]	[2017]	[4967]	[3222]	[9971]	[6450]
Total Stroke	mm	13	26	16	32	25	50	35	70
	[in]	[0.51]	[1.02]	[0.63]	[1.26]	[0.98]	[1.97]	[1.38]	[2.76]
Weight	kg [lbs]	3.9 [8.6]		7.89 [17.4]		15.7 [34.6]		43.9 [96.8]	
Pressure Range w/o Spring	bar [psi]	2-7 [30-100]							
Pressure Range with Spring	bar [psi]	3-7 [45-100]		4-7 [55-100]			3.5-7 [50-100]		
Max. Vacuum for Scavenge Port	mm Hg [in Hg]	20 [8]							
Max. Pressure for Purge Port	bar [psi]	2.1 [30]							
Displacement	cm ³ [in ³]	180 [11.0]		355 [22]		940 [57]		2720 [166]	
Temperature Range	°C [°F]	Buna-N -35°~80° [-30°~180°], Viton -30°~150° [-20°~300°]							
Actuation (open/close)	sec.	0.19		0.236		0.85		1.7	

Accessories

Sensor Accessories	Model Numbers	Part Number	Qty/Unit
8mm PNP Magneto Resistive Sensor (90° barrel) w/ M8 Qk. Disc*	All Models	OHSP-011	1-3†
8mm NPN Magneto Resistive Sensor (90° barrel) w/ M8 Qk. Disc*	All Models	OHSN-011	1-3†
8mm PNP Magneto Resistive Sensor Short Barrel w/ M8 Qk Disc*	All Models	OHSP-017	1-3†
8mm NPN Magneto Resistive Sensor Short Barrel w/ M8 Qk Disc*	All Models	OHSN-017	1-3†
8mm PNP Inductive Sensor w/ M12 Quick Disconnect*	RTH-4M, -5M, -6M	OISP-011	1-3
8mm NPN Inductive Sensor w/ M12 Quick Disconnect*	RTH-4M, -5M, -6M	OISN-011	1-3
12mm PNP Inductive Sensor w/ M12 Quick Disconnect*	RTH-7M, -8M	OISP-017	1-3
12mm NPN Inductive Sensor w/ M12 Quick Disconnect*	RTH-7M, -8M	OISN-017	1-3
M8 Quick Disconnect 2 Meter Cable Length*	All Models	CABL-010	1-3
M8 Quick Disconnect 5 Meter Cable Length*	All Models	CABL-013	1-3
M12 Quick Disconnect 2 Meter Cable Length*	RTH-7M, -8M	CABL-014	1-3†
M12 Quick Disconnect 5 Meter Cable Length*	RTH-7M, -8M	CABL-018	1-3†

Pneumatic Accessories	Model Numbers	Part Number	Qty/Unit
M5 Adjustable Flow Control	RTH-1M, -2M, -3M	VLVF-008	1-2
G 1/8" 90° Adjustable Flow Control	RTH-4M, -5M, -6M, -7M	VLVF-005	1-2
G 1/4" Adjustable Flow Control	RDH-8M	VLVF-010	1-2

* Sensor and cable sold separately. † Except RTH-1, 1-2 only.

Dimensions and technical information are subject to change without notice

PPC SERIES

3-Jaw Parallel Grippers

CLICK OR SCAN

To view full catalog pages on this product



How To Order

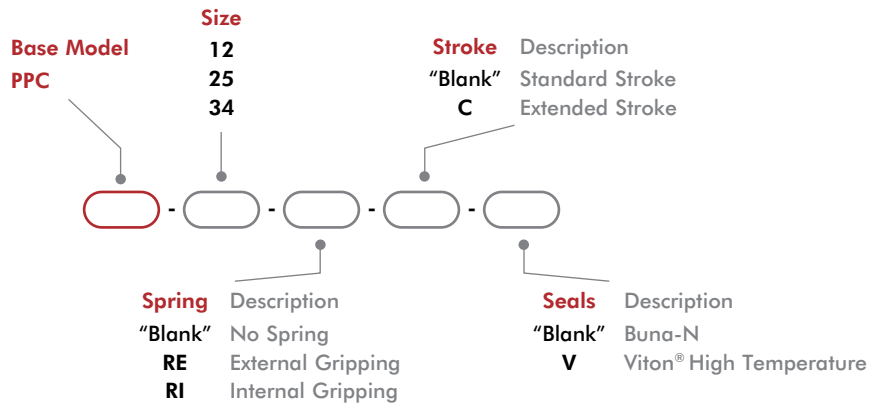

Basic Unit Dimensions

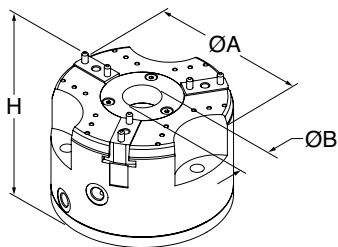

Size	Ø	H
12	43 [1.69]	74 [2.91]
12-C	49.03 [1.93]	78 [3.07]
25	61.5 [2.42]	87 [3.43]
25-C	68.5 [2.70]	92 [3.62]
34	82.5 [3.25]	112 [4.41]
34-C	92.5 [3.64]	117 [4.61]

**CLICK OR SCAN**

To view full catalog pages on this product

PPC SERIES

3-Jaw Parallel Grippers

Technical Data

Specifications	Units	12	12-C	25	25-C
Total Rated Grip Force F @ 100 psi [7 bar]*	N [lbs]	1474 [331]	896 [201]	2620 [589]	1642 [369]
Total Stroke	mm [in]	10 [0.394]	16 [0.630]	13 [0.512]	20 [0.787]
Weight	kg [lbs]	1.0 [2.2]	1.1 [2.4]	2.2 [4.9]	2.3 [5.1]
Pressure Range (without spring)	bar [psi]	2-7 [30-100]			
Pressure Range (with spring)	bar [psi]	3-7 [45-100]			
Displacement	cm ³ [in ³]	23 [1.40]		51 [3.11]	
Temperature Range (Buna-N seals)	°C [°F]	-35°~80° [-30°~180°]			
Temperature Range (Viton® seals)	°C [°F]	-30°~150° [-20°~300°]			
Actuation (open/close)	sec.	0.03		0.04	

Specifications	Units	34	34-C
Total Rated Grip Force F @ 100 psi [7 bar]*	N [lbs]	4332 [974]	2938 [638]
Total Stroke	mm [in]	20 [0.787]	30 [1.181]
Weight	kg [lbs]	5.1 [11.2]	5.3 [11.7]
Pressure Range (without spring)	bar [psi]	2-7 [30-100]	
Pressure Range (with spring)	bar [psi]	3-7 [45-100]	
Displacement	cm ³ [in ³]	128 [7.81]	
Temperature Range (Buna-N seals)	°C [°F]	-35°~80° [-30°~180°]	
Temperature Range (Viton® seals)	°C [°F]	-30°~150° [-20°~300°]	
Actuation (open/close)	sec.	0.06	

*With springs

Accessories

Sensor Accessories	Model Numbers	Part Number	Qty/Unit
Inductive Sensor Mounting Kit (1 Holder, 1 Flag, 2 Spacers)	PPC-12	OSMK-105	1-2
Inductive Sensor Mounting Kit (1 Holder, 1 Flag, 2 Spacers)	PPC-25	OSMK-106	1-2
Inductive Sensor Mounting Kit (1 Holder, 1 Flag, 2 Spacers)	PPC-34	OSMK-107	1-2
NPN Inductive Sensor with Quick Disconnect*	All Models	OISN-011	1-4
PNP Inductive Sensor with Quick Disconnect*	All Models	OISP-011	1-4
Quick Disconnect Cable (2 meters long)*	All Models	CABL-010	1-4
Quick Disconnect Cable (5 meters long)*	All Models	CABL-013	1-4

*Sensor and cable sold separately.

REP3 SERIES

3-Jaw Parallel Grippers

How To Order

CLICK OR SCAN

To view full catalog pages on this product



(USB key shown for scale)

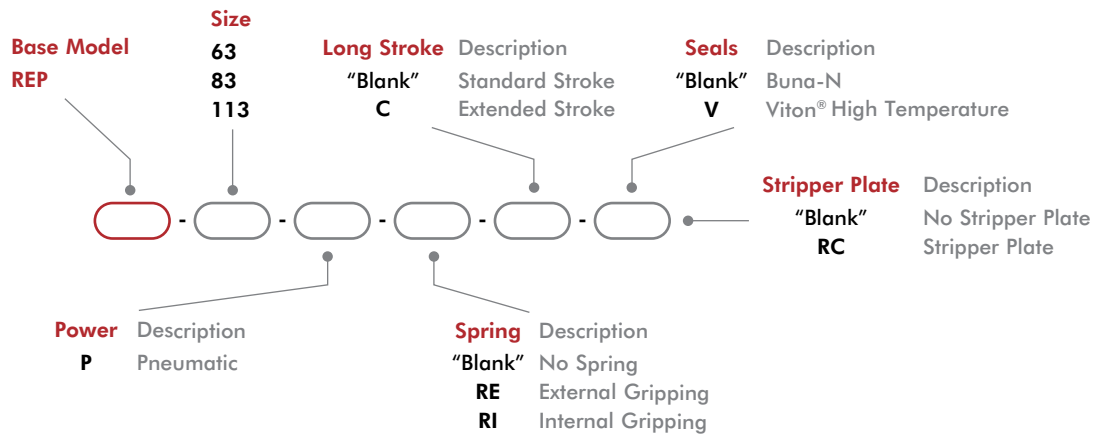

Size	Seal Repair Kits	
	Buna-N	Viton®
63P	SLKT-155	SLKT-155V
83P	SLKT-157	SLKT-157V
113P	SLKT-158	SLKT-158V

**CLICK OR SCAN**

To view full catalog pages on this product

REP3 SERIES

3-Jaw Parallel Grippers

Basic Unit Dimensions

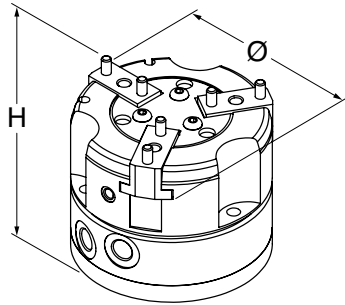

Size	Ø	H
63P	72 [2.83]	77 [3.03]
63P-C	78 [3.07]	
83P	91.6 [3.61]	78 [3.07]
83P-C	98.4 [3.87]	
113P	126 [4.96]	103 [4.06]
113P-C	136 [5.35]	

Technical Data

Specifications	Units	63	63-C	83	83-C	113	113-C
Total Rated Grip Force F @ 100 psi [7 bar]*	N [lbs]	753 [169]	469 [105]	2077 [467]	1341 [301]	3268 [735]	2180 [490]
Total Stroke	mm [in]	10 [0.394]	16 [0.630]	13 [0.512]	20 [0.787]	20 [0.787]	30 [1.181]
Weight	kg [lbs]	0.55 [1.2]		0.9 [2.0]		2.45 [5.4]	
Pressure Range w/o Spring	bar [psi]	2-7 [30-100]					
Pressure Range with Spring	bar [psi]	3-7 [45-100]					
Displacement	cm ³ [in ³]	12 [0.72]		35 [2.13]		87 [5.31]	
Temperature Range (Buna-N seals)	°C [°F]	-35°~80° [-30°~180°]					
Temperature Range (Viton® seals)	°C [°F]	-30°~150° [-20°~300°]					
Actuation (open/close)	sec.	0.10		0.18		0.35	

* with springs

Accessories

Sensor Accessories	Model Numbers	Part Number	Qty/Unit
NPN Inductive Sensor with M8 Quick Disconnect*	All Models	OISN-011	1-4
PNP Inductive Sensor with M8 Quick Disconnect*	All Models	OISP-011	1-4
NPN Magneto Resistive Sensor with Quick Disconnect*	All Models	OHSN-006	1-2
PNP Magneto Resistive Sensor with Quick Disconnect*	All Models	OHSP-006	1-2
NPN Magneto Resistive Sensor (Short Barrel) with Qk Disconnect*	All Models	OHSN-017	1-2
PNP Magneto Resistive Sensor (Short Barrel) with Qk Disconnect*	All Models	OHSP-017	1-2
M8 Quick Disconnect 2 Meter Cable Length*	All Models	CABL-010	1-4
M8 Quick Disconnect 2 Meter Cable Length*	All Models	CABL-013	1-4
Inductive Sensor Kit (Mounts 2 Sensors)	63	OSMK-105	1-2
Inductive Sensor Kit (Mounts 2 Sensors)	83	OSMK-106	1-2
Inductive Sensor Kit (Mounts 2 Sensors)	113	OSMK-107	1-2

* Sensor and cable sold separately.

RPC SERIES

3-Jaw Parallel Grippers

CLICK OR SCAN

To view full catalog pages on this product



How To Order

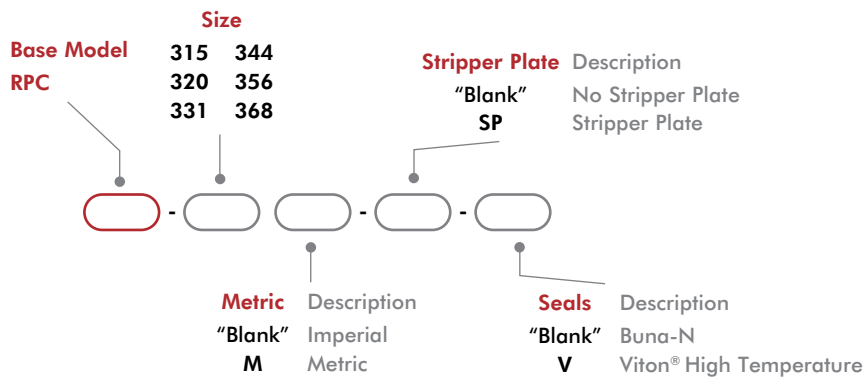

Basic Unit Dimensions

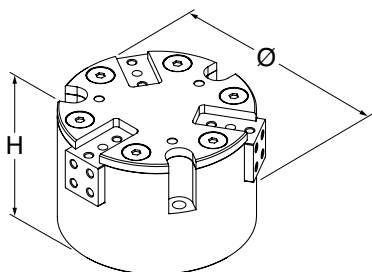

Size	Ø	H
315	62 [2.44]	41 [1.61]
320	82 [3.23]	50 [1.97]
331	118 [4.65]	75.1 [2.96]
344	140 [5.51]	82.2 [3.24]
356	184 [7.24]	101.1 [3.98]
368	206 [8.11]	118 [4.65]



Technical Data

Specifications	Units	315	320	331
Total Rated Grip Force F @ 100 psi [7 bar]*	N [lbs]	445 [100]	1334 [300]	3336 [750]
Total Stroke	mm [in]	7.6 [0.30]	10.2 [0.40]	15.7 [0.62]
Weight	kg [lbs]	0.24 [0.53]	0.45 [1.0]	1.4 [3.0]
Pressure Range	bar [psi]	1.4-7 [20-100]		
Displacement	cm ³ [in ³]	5.2 [0.32]	17.7 [1.08]	52.3 [3.31]
Temperature Range (Buna-N seals)	°C [°F]	-35°~80° [-30°~180°]		
Temperature Range (Viton® seals)	°C [°F]	-30°~150° [-20°~300°]		
Actuation	sec.	0.12	0.18	0.23

Specifications	Units	344	356	368
Total Rated Grip Force F @ 100 psi [7 bar]*	N [lbs]	4003 [900]	6339 [1425]	13345 [3000]
Total Stroke	mm [in]	22.2 [0.88]	28.4 [1.12]	34.9 [1.38]
Weight	kg [lbs]	2.7 [6.0]	4.4 [9.75]	7.3 [16]
Pressure Range	bar [psi]	1.4-7 [20-100]		
Displacement	cm ³ [in ³]	120 [7.37]	253 [13.46]	424 [25.86]
Temperature Range (Buna-N seals)	°C [°F]	-35°~80° [-30°~180°]		
Temperature Range (Viton® seals)	°C [°F]	-30°~150° [-20°~300°]		
Actuation	sec.	0.47	0.50	0.74

*With springs

Accessories

Sensor Accessories	Model Numbers	Part Number	Qty/Unit
4mm NPN Magneto Resistive Sensor with Quick Disconnect*	All Models	OHSN-017	1-2
4mm PNP Magneto Resistive Sensor with Quick Disconnect*	All Models	OHSP-017	1-2
4mm NPN 90° Magneto Resistive Sensor with Quick Disconnect*	All Models	OHSN-011	1-2
4mm PNP 90° Magneto Resistive Sensor with Quick Disconnect*	All Models	OHSP-011	1-2
Quick Disconnect Cable (2 meters long)*	All Models	CABL-010	1-2
Quick Disconnect Cable (5 meters long)*	All Models	CABL-013	1-2
Fail Safe Valve (Imperial)	315, 320, 331	OFSV-001	1
Fail Safe Valve (Metric)	315, 320, 331	OFSV-004	1
Fail Safe Valve (Imperial)	344, 356, 368	OFSV-002	1
Fail Safe Valve (Metric)	344, 356, 368	OFSV-005	1

*Sensor and cable sold separately.

CT/DCT & CT-RE/DCT-RE SERIES

CLICK OR SCAN

To view full catalog pages on this product



Angular Grippers

How To Order



Base Model	Size	Seals	Description
DCT (sizes 12-25 only)	12M 25M 50M	"Blank"	Buna-N
CT (sizes 32-50 only)	16M 32M 20M 40M	V	Viton® High Temperature

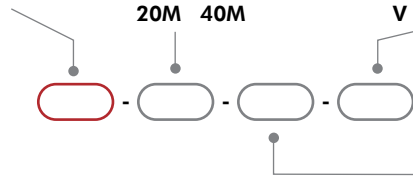

Spring	Description
"Blank"	None
RE	Spring Closed

Size	Seal Repair Kits		Adjustment Stop Kit (1 shielded plate, 1 stop)	Inductive Sensor Mounting Kit (mounts 2 sensors)
	Buna-N	Viton®		
12M/12M-RE	SLKT-159	SLKT-159V	KP-DCT12-BR	N/A
16M/16M-RE	SLKT-160	SLKT-160V	KP-DCT16-BR	SDCT-16-20
20M/20M-RE	SLKT-161	SLKT-161V	KP-DCT20-BR	
25M/25M-RE	SLKT-162	SLKT-162V	KP-DCT25-BR	SDCT-25-32
32M/32M-RE	SLKT-163	SLKT-163V	KP-CT32-BR	
40M/40M-RE	SLKT-164	SLKT-164V	KP-CT40-BR	
50M/50M-RE	SLKT-165	SLKT-165V	KP-CT50-BR	SDCT-40-63

Basic Unit Dimensions

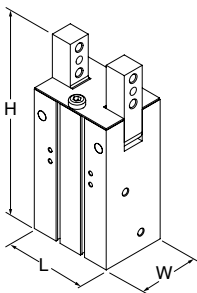

Size	L	W	H -CT	H -CT-RE
12M	30 [1.18]	20 [0.79]	48 [1.89]	64 [2.52]
16M	36 [1.42]	25 [0.98]	64 [2.52]	71 [2.80]
20M	42 [1.65]	30 [1.18]	79 [3.11]	83 [3.27]
25M	50 [1.97]	36 [1.42]	93.5 [3.68]	102 [4.02]
32M	56 [2.20]	42 [1.65]	95 [3.74]	116 [4.57]
40M	66 [2.60]	52 [2.05]	107.5 [4.23]	135 [5.31]
50M	76 [2.99]	62 [2.44]	146 [5.75]	163 [6.42]

**CLICK OR SCAN**

To view full catalog pages on this product

CT/DCT & CT-RE/DCT-RE SERIES

Angular Grippers

Technical Data

Specifications	Units	12M	12M-RE	16M	16M-RE	20M	20M-RE	25M	25M-RE
Total Rated Grip Force F @ 100 psi [7 bar]	N [lb]	32 [7.2]	40 [9]	70 [16]	87 [19]	112 [25]	141 [32]	157 [35]	199 [45]
Stroke		90° per finger (180° total)							
Weight	kg [lbs]	0.09 [0.20]	0.12 [0.26]	0.16 [0.35]	0.20 [0.44]	0.28 [0.62]	0.33 [0.73]	0.49 [1.08]	0.57 [1.26]
Pressure Range	bar [psi]	CT/DCT w/spring 3-7 [40-100], CT-RE/DCT-RE w/o spring 4-7 [60-100]							
Ingress Protection Class (IP)		IP43							
Displacement	cm ³ [in ³]	1.92 [0.117]		4.12 [0.251]		7.92 [0.483]		14.9 [0.909]	
Temperature Range (Buna-N seals)	°C [°F]	-35°~80° [-30°~180°]							
Temperature Range (Viton® seals)	°C [°F]	-30°~150° [-20°~300°]							
Actuation (open)	sec	0.06	0.08	0.13	0.15	0.16	0.20	0.21	0.25
Actuation (close)	sec	0.06	0.05	0.13	0.12	0.16	0.14	0.21	0.19

Specifications	Units	32M	32M-RE	40M	40M-RE	50M	50M-RE
Total Rated Grip Force F @ 100 psi [7 bar]	N [lb]	272 [61]	353 [79]	446 [100]	592 [133]	651 [146]	893 [201]
Stroke		90° per finger (180° total)					
Weight	kg [lbs]	0.72 [1.59]	0.83 [1.83]	1.18 [2.60]	1.39 [3.06]	1.82 [4.01]	2.21 [4.87]
Pressure Range	bar [psi]	CT/DCT w/spring 3-7 [40-100], CT-RE/DCT-RE w/o spring 4-7 [60-100]					
Ingress Protection Class (IP)		IP43					
Displacement	cm ³ [in ³]	28.6 [1.745]		52 [3.173]		92 [5.614]	
Temperature Range (Buna-N seals)	°C [°F]	-35°~80° [-30°~180°]					
Temperature Range (Viton® seals)	°C [°F]	-30°~150° [-20°~300°]					
Actuation (open)	sec	0.29	0.35	0.41	0.47	0.46	0.54
Actuation (close)	sec	0.29	0.26	0.41	0.38	0.46	0.42

Accessories

Sensor Accessories	Model Numbers	Part Number	Qty/Unit
NPN Magneto Resistive Sensor with M8 Quick Disconnect	All Models	OHSN-017	1-2
PNP Magneto Resistive Sensor with M8 Quick Disconnect	All Models	OHSP-017	1-2
Inductive Sensor Mounting Kit (mounts 2 sensors)	See Above		1
4mm NPN Inductive Sensor with M8 Quick Disconnect*	16M, 20M	OISN-014	1-2
4mm PNP Inductive Sensor M8 with Quick Disconnect*	16M, 20M	OISP-014	1-2
M8 NPN Inductive Sensor with M8 Quick Disconnect*	25M, 32M	OISN-011	1-2
M8 PNP Inductive Sensor with M8 Quick Disconnect*	25M, 32M	OISP-011	1-2
M12 NPN Inductive Sensor with M12 Quick Disconnect*	40M, 50M	OISN-017	1-2
M12 PNP Inductive Sensor with M12 Quick Disconnect*	40M, 50M	OISP-017	1-2
M8 Quick Disconnect 2 Meter Cable Length*	All Models	CABL-010	1-2
M8 Quick Disconnect 5 Meter Cable Length*	All Models	CABL-013	1-2
M12 Quick Disconnect 2 Meter Cable Length*	All Models	CABL-014	1-2
M12 Quick Disconnect 5 Meter Cable Length*	All Models	CABL-018	1-2

Pneumatic Accessories	Model Numbers	Part Number	Qty/Unit
Adjustable Flow Control-M5 Elbow-6mm OD Push-in	12M, 16M, 20M, 25M, 32M	VLVF-008	1-2
Adjustable Flow Control-G1/8 Elbow-6mm OD Push-in	40M, 50M	VLVF-005	1-2

*Sensor and cable sold separately.

Dimensions and technical information are subject to change without notice

RA (CAM DRIVEN) SERIES

Angular Grippers

How To Order

CLICK OR SCAN

To view full catalog pages on this product

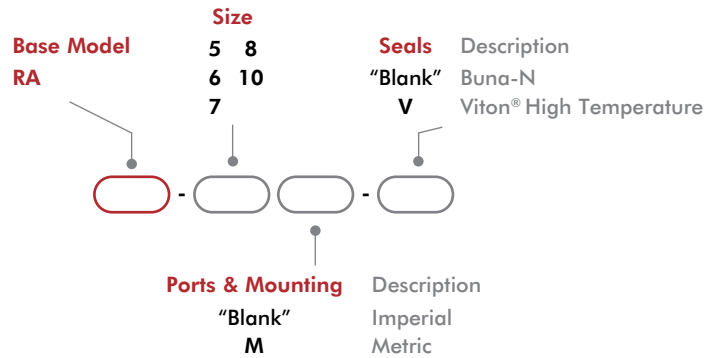
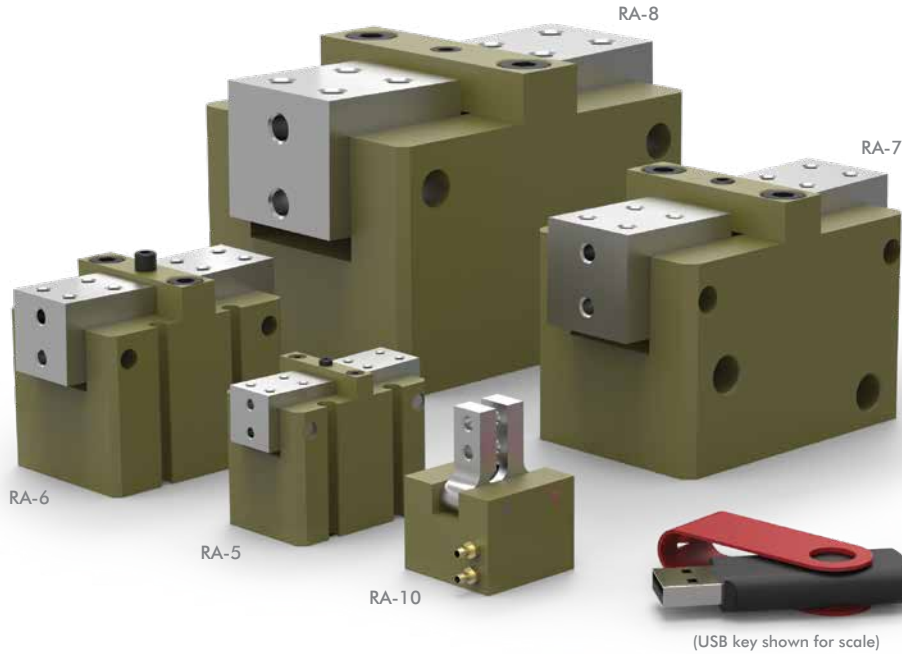

Size	Seal Repair Kits	
	Buna-N	Viton®
5	SLKT-022	SLKT-022V
6	SLKT-023	SLKT-023V
7	SLKT-118	SLKT-118V
8	SLKT-119	SLKT-119V
10	SLKT-018	SLKT-018V

Basic Unit Dimensions

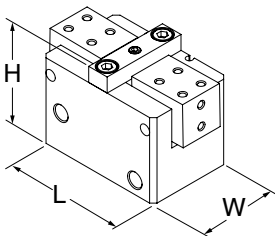

Size	L	W	H
5	25.4 [1.00]	38.1 [1.50]	35.0 [1.38]
6	38.1 [1.50]	50.8 [2.00]	49.6 [1.95]
7	50.8 [2.00]	76.2 [3.00]	60.8 [2.39]
8	76.2 [3.00]	101.6 [4.00]	76.2 [3.00]
10	25.4 [1.00]	25.4 [1.00]	20.7 [0.81]

**CLICK OR SCAN**

To view full catalog pages on this product

RA (CAM DRIVEN) SERIES

Angular Grippers

Technical Data

Specifications	Units	5	6	7
Total Rated Grip Force F @ 7 bar [100 psi]	N [lbs]	89 [20]	196 [44]	534 [120]
Total Stroke		15° per finger (30° total)		
Open Stroke Adjustment		15° per finger (30° total)		10° per finger (20° total)
Weight	kg [lbs]	0.11 [0.25]	0.31 [0.69]	0.8 [1.8]
Pressure Range	bar [psi]	3-7 [40-100]		
Ingress Protection Class (IP)		IP43		
Displacement	cm ³ [in ³]	2.1 [0.13]	4.9 [0.300]	9.8 [0.601]
Temperature Range (Buna-N seals)	°C [°F]	-35°~80° [-30°~180°]		
Temperature Range (Viton® seals)	°C [°F]	-30°~150° [-20°~300°]		
Actuation	sec	0.10	0.11	0.15

Specifications	Units	8	10
Total Rated Grip Force F @ 7 bar [100 psi]	N [lbs]	801 [180]	71 [16]
Total Stroke		15° per finger (30° total)	
Open Stroke Adjustment		10° per finger (20° total)	--
Weight	kg [lbs]	2.1 [4.6]	0.03 [0.063]
Pressure Range	bar [psi]	3-7 [40-100]	
Ingress Protection Class (IP)		IP43	
Displacement	cm ³ [in ³]	21.6 [1.320]	0.4 [0.026]
Temperature Range (Buna-N seals)	°C [°F]	-35°~80° C [-30°~180° F]	
Temperature Range (Viton® seals)	°C [°F]	-30°~150° C [-20°~300° F]	
Actuation	sec	0.23	0.08

Accessories

Sensor Accessories	Model Numbers	Part Number	Qty/Unit
NPN Magneto Resistive Sensor with Quick Disconnect*	5, 6, 7, 8	OHSN-017	1-2
PNP Magneto Resistive Sensor with Quick Disconnect*	5, 6, 7, 8	OHSP-017	1-2
NPN Magneto Resistive Sensor 90° with Quick Disconnect*	5, 6, 7, 8	OHSN-011	1-2
PNP Magneto Resistive Sensor 90° with Quick Disconnect*	5, 6, 7, 8	OHSP-011	1-2
Quick Disconnect 2 Meter Cable Length*	5, 6, 7, 8	CABL-010	1-2
Quick Disconnect 5 Meter Cable Length*	5, 6, 7, 8	CABL-013	1-2

Pneumatic Accessories	Model Numbers	Part Number	Qty/Unit
Fail Safe Valve (Imperial)	5, 6	OFSV-001	1
Fail Safe Valve (Metric)	5, 6	OFSV-004	1
Fail Safe Valve (Imperial)	7, 8	OFSV-002	1
Fail Safe Valve (Metric)	7, 8	OFSV-005	1

*Sensor and cable sold separately.

RA (TOGGLE LOCK) SERIES

Angular Grippers

How To Order

CLICK OR SCAN

To view full catalog pages on this product



(USB key shown for scale)

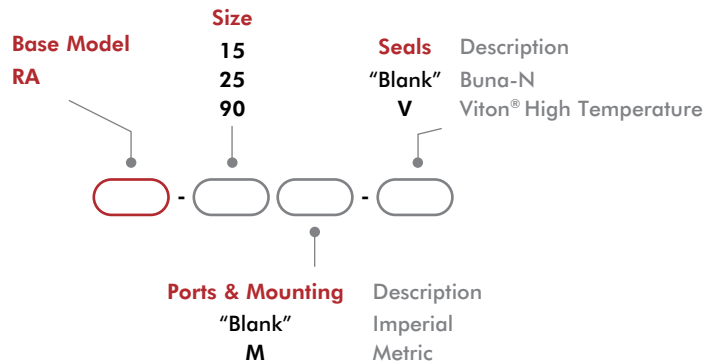

Size	Inductive Sensor Mounting Kit (mounts 2 sensors)	Seal Repair Kits	
		Buna-N	Viton®
15	OSMK-018	SLKT-019	SLKT-019V
25	OSMK-019	SLKT-020	SLKT-020V
90	OSMK-003	SLKT-024	SLKT-024V

**CLICK OR SCAN**

To view full catalog pages on this product

RA (TOGGLE LOCK) SERIES

Angular Grippers

Basic Unit Dimensions

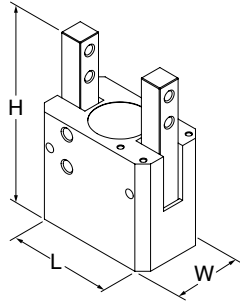

Size	L	W	H
15	25.4 [1.00]	44.5 [1.75]	38.9 [1.53]
25	44.5 [1.75]	63.5 [2.50]	61.9 [2.44]
90	39 [1.54]	28 [1.10]	67.3 [2.65]

Technical Data

Specifications	Units	15	25	90
Total Rated Grip Force F @ 100 psi [7 bar]	N [lbs]	311 [70]	1112 [250]	356 [80]
Total Stroke		6° per finger (12° total)		90° per finger (180° total)
Stroke Adjustment		--		45° per finger (90° total)
Weight	kg [lbs]	0.14 [0.31]	0.48 [1.06]	0.20 [0.438]
Pressure Range	bar [psi]	3-7 [40-100]		
Ingress Protection Class (IP)		IP43		
Displacement	cm ³ [in ³]	1.8 [0.110]	0.8 [0.046]	7.5 [0.460]
Temperature Range (Buna-N seals)	°C [°F]	-35°~80° [-30°~180°]		
Temperature Range (Viton® seals)	°C [°F]	-30°~150° [-20°~300°]		
Actuation	sec	0.10	0.12	0.16

Accessories

Sensor Accessories	Model Numbers	Part Number	Qty/Unit
Sensor Mounting Kit, Mounts 2 Inductive Sensors (Imperial/Metric)	See Datasheet		1
NPN Inductive Sensor with Quick Disconnect*	15, 90	OISN-019	1-2
PNP Inductive Sensor with Quick Disconnect*	15, 90	OISP-019	1-2
NPN Inductive Sensor with Quick Disconnect*	25	OISN-014	1-2
PNP Inductive Sensor with Quick Disconnect*	25	OISP-014	1-2
NPN Magneto Resistive Sensor with Quick Disconnect*	90	OHSN-017	1-2
PNP Magneto Resistive Sensor with Quick Disconnect*	90	OHSP-017	1-2
NPN Magneto Resistive Sensor 90° with Quick Disconnect*	90	OHSN-011	1-2
PNP Magneto Resistive Sensor 90° with Quick Disconnect*	90	OHSP-011	1-2
Quick Disconnect 2 Meter Cable Length*	All Models	CABL-010	1-2
Quick Disconnect 5 Meter Cable Length*	All Models	CABL-013	1-2

Pneumatic Accessories	Model Numbers	Part Number	Qty/Unit
#10-32 to 1/4" OD Tube Flow Controls	90	VLVF-007	2
M5 to 6mm OD Tube Flow Controls	90	VLVF-008	2

*Sensor and cable sold separately.

RUA SERIES

Angular Grippers

CLICK OR SCAN

To view full catalog pages on this product



How To Order

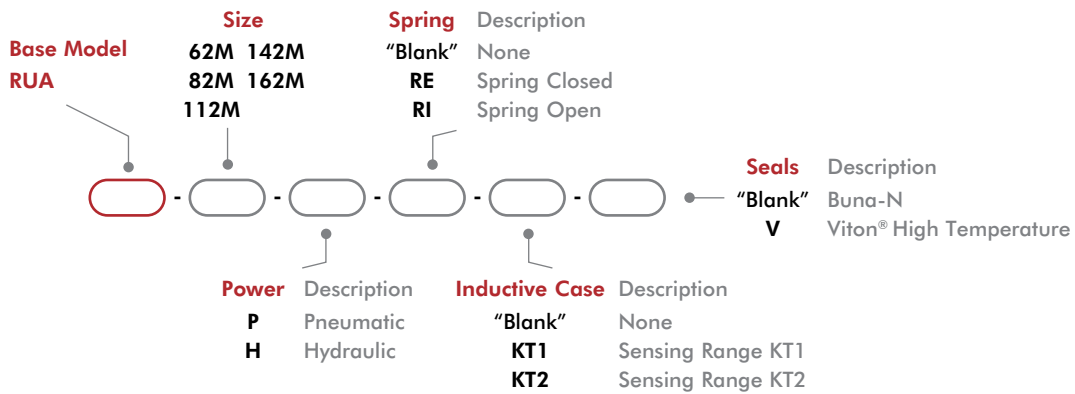

Size	Seal Repair Kits Buna-N Standard	Seal Repair Kits Viton®	Sealed Boots (2 interfaces, 1 collar, 1 boot)	
			PVC	Kevlar
62M	OSMK-156	OSMK-156V	SLKT-367	SLKT-368
82M	OSMK-157	OSMK-157V	SLKT-370	SLKT-371
112M	OSMK-158	OSMK-158V	SLKT-373	--
142M	OSMK-333	OSMK-333V	SLKT-376	--
162M	OSMK-335	OSMK-335V	SLKT-379	--

**CLICK OR SCAN**

To view full catalog pages on this product

RUA SERIES

Angular Grippers

Basic Unit Dimensions

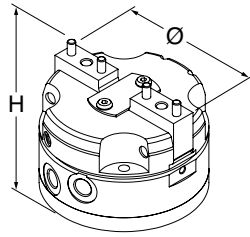

Size	Ø	H
62M	Ø60 [Ø2.36]	53 [2.09]
82M	Ø80 [Ø3.15]	57 [2.24]
112M	Ø110 [Ø4.33]	175 [6.89]
142M	Ø140 [Ø5.51]	107 [4.21]
162M	Ø165 [Ø6.50]	119 [4.69]

Technical Data

Specifications	Units	62M	82M	112M
Total Rated Grip Force L=25mm [1 in.] @ 0°				
@ 7 bar [100 psi], w/spring	N [lbs]	384 [86]	1228 [276]	2150 [483]
@ 7 bar [100 psi], w/o spring	N [lbs]	313 [70]	922 [207]	1600 [360]
Total Stroke		16.8° per finger (33.6° total)	15.9° per finger (31.8° total)	19.1° per finger (38.2° total)
Weight	kg [lbs]	0.39 [0.86]	0.70 [1.55]	1.70 [3.75]
Pressure Range	bar [psi]	w/o springs 2-7 [30-100] /with springs -RE, -RI 3-7 [45-100]		
Displacement	cm ³ [in ³]	12 [0.73]	35 [2.14]	85 [5.19]
Temperature Range (Buna-N seals Standard)	°C [°F]	-35°~80° [-30°~180°]		
Temperature Range (Viton® seals)	°C [°F]	-30°~150° [-20°~300°]		
Actuation	sec	0.18	0.10	0.35

Specifications	Units	142M	162M
Total Rated Grip Force L=25mm [1 in.] @ 0°			
@ 7 bar [100 psi], w/spring	N [lbs]	5775 [1298]	5490 [1234]
@ 7 bar [100 psi], w/o spring	N [lbs]	3941 [886]	3790 [853]
Total Stroke		17.6° per finger (35.2° total)	17.2° per finger (34.4° total)
Weight	kg [lbs]	4.1 [9.05]	6.7 [14.8]
Pressure Range	bar [psi]	w/o springs 2-7 [30-100] /with springs -RE, -RI 3-7 [45-100]	
Displacement	cm ³ [in ³]	215 [13.2]	322 [19.7]
Temperature Range (Buna-N seals Standard)		-35°~80° [-30°~180°]	
Temperature Range (Viton® seals)	°C [°F]	-30°~150° [-20°~300°]	
Actuation	sec	0.60	0.80

Accessories

Sensor Accessories	Model Numbers	Part Number	Qty/Unit
NPN Magneto Resistive Sensor with Quick Disconnect* **	62M, 82M, 112M	OHSN-017	1-2
PNP Magneto Resistive Sensor with Quick Disconnect* **	62M, 82M, 112M	OHSP-017	1-2
NPN Magneto Resistive Sensor 90° with Quick Disconnect* **	62M, 82M, 112M	OHSN-011	1-2
PNP Magneto Resistive Sensor 90° with Quick Disconnect* **	62M, 82M, 112M	OHSP-011	1-2
Replacement PNP Double Inductive Sensor* †	All Models	KT15	1
Quick Disconnect 2 Meter Cable Length*	62M, 82M, 112M	CABL-010	1-2
Quick Disconnect 5 Meter Cable Length*	62M, 82M, 112M	CABL-013	1-2
Quick Disconnect 2 Meter Cable Length (for KT Inductive Sensor)*	All Models	CABL-014	1-2

*Sensor and cable sold separately. **Piston magnet standard. †Requires KT1 or KT2 sensor option.

FUA SERIES

Angular Food Grippers

How To Order



(USB key shown for scale)

Base Model
FUA-50M
FUA-63M



Spring	Description
"Blank"	None
C	Spring Closed

CLICK OR SCAN

To view full catalog pages on this product



See page 5-8 for product availability in your region.

Technical Data

Specifications	Units	FUA-50M	FUA-63M
Torque, Jaws @ 0° (mid-stroke)			
@ 6 bar [87 psi], w/spring	Nm [in-lbs]	13 [115]	32 [283]
@ 0 bar [0 psi], w/spring	Nm [in-lbs]	16 [142]	9 [80]
Total Stroke		14 [124]	70°
Weight (Stainless Steel)	kg [lbs]	70°	1.7 [3.75]
Weight (Polymer)	kg [lbs]	1,06 [2.34]	0.8 [1.76]
Pressure Range without springs	bar [psi]	3-7 [44-100]	2-7 [30-100]
Pressure Range with springs	bar [psi]	IP69K	3.5-7 [50-100]
Ingress Protection Class (IP)		30,2 [1.84]	IP69K
Displacement	cm ³ [in ³]	-15°~80° [5°~175°]	54 [3.30]
Temperature Range	°C [°F]	0.07 / 0.07	-15°~80° [5°~175°]

Basic Unit Dimensions

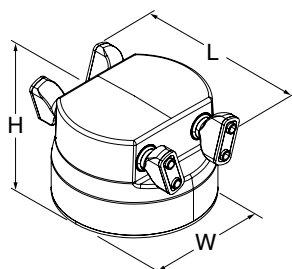

Size	L	W	H
FUA-50	85 [3.35]	75 [2.95]	52 [2.05]
FUA-63	100 [3.94]	90 [3.54]	62 [2.44]

RR LIGHT-DUTY SERIES

Rotary Actuators

How To Order

CLICK OR SCAN

To view full catalog pages on this product

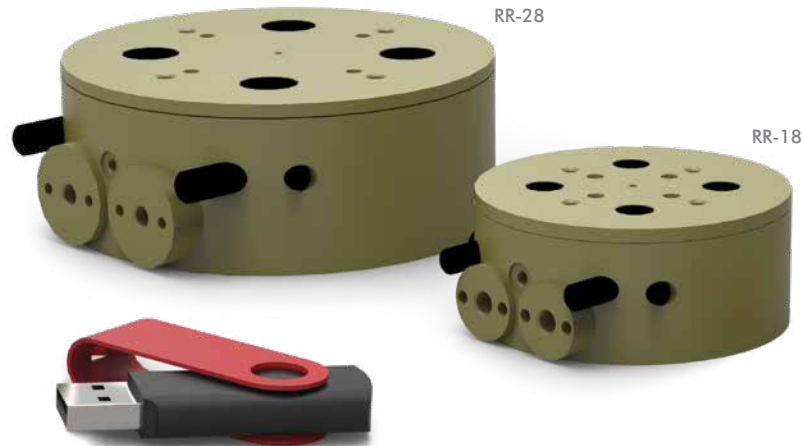

(USB key shown for scale)

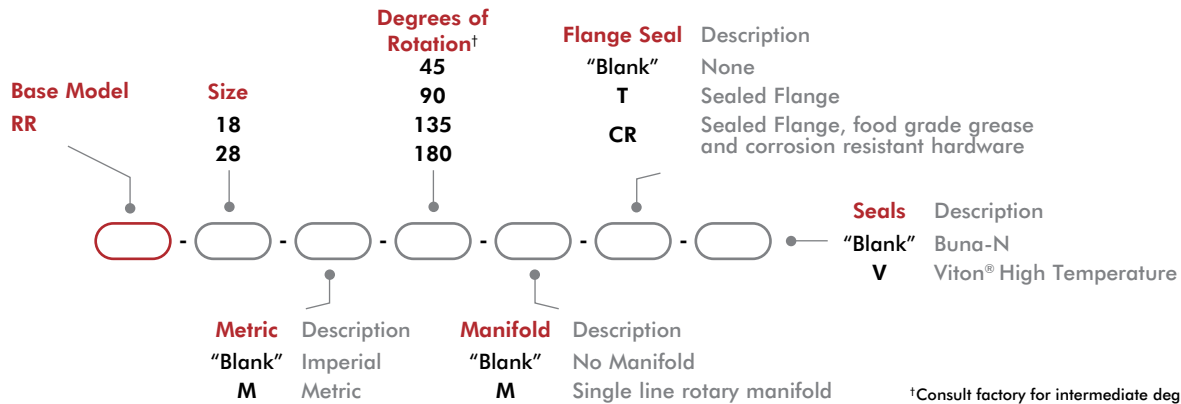

Size	Base Unit Seal Repair Kits		Bottom Air Port Manifold Seal Kit - Viton®
	Buna-N	Viton®	
18	SLKT-173	SLKT-173V	SLKT-174V
28	SLKT-175	SLKT-175V	SLKT-176V

Basic Unit Dimensions

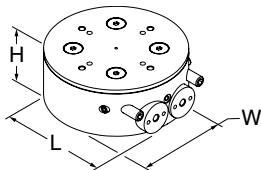

Size	L	W	H
18	170.9 [6.73]	101.6 [4.00]	43.7 [1.72]
28	203.2 [8.00]	113.5 [4.47]	54.1 [2.13]

**CLICK OR SCAN**

To view full catalog pages on this product

RR LIGHT-DUTY SERIES

Rotary Actuators

Technical Data

Specifications	Units	18	28
Maximum Payload	kg [lb]	0.45 [1.0]	1.36 [3.0]
Maximum Payload Inertia	Nm sec ² [in-lbs sec ²]	0.000181 [0.0016]	0.001255 [0.0111]
Maximum Rotation		180°	
Maximum Torque Mid-Stroke @ 7 bar [100psi]	Nm [lbs-in]	0.7 [6.5]	2.5 [22]
Maximum Torque End-Stroke @ 7 bar [100psi]			
Pitch Diameter of Pinion	mm [in]	8.46 [0.333]	12.7 [0.50]
Weight	kg [lb]	0.22 [0.48]	0.65 [1.44]
Pressure Range	bar [psi]	2-7 [30-100]	
Displacement 180°	cm ³ [in ³]	3.37 [0.205]	11.4 [0.69]
Temperature Range (Buna-N seals)	°C [°F]	-35°~80° [-30°~180°]	
Temperature Range (Viton® seals)	°C [°F]	-30°~150° [-20°~300°]	
Actuation Time 180° @ 5,5 bar [80 psi]	sec	0.30	0.35
Actuation Time 90° @ 5,5 bar [80 psi]	sec	0.25	0.30
Over Travel (each end)		4°	8°

Accessories

Sensor Accessories	Model Numbers	Part Number	Qty/Unit
Sensor Mounting Kit (mounts 2 sensors)	All Models	OSMK-024	1
NPN Inductive Sensor with Quick Disconnect*	All Models	OISN-014	1-2
PNP Inductive Sensor with Quick Disconnect*	All Models	OISP-014	1-2
Quick Disconnect 2 Meter Cable Length*	All Models	CABL-010	1-2
Quick Disconnect 5 Meter Cable Length*	All Models	CABL-013	1-2
Pneumatic Accessories	Model Numbers	Part Number	Qty/Unit
M3 Plumbing Fitting Push-In for 3mm OD Tube	All Models	PLFT-021	2
M3 Plumbing Fitting Barb for 2mm ID Tube	All Models	PLFT-022	2
#10-32 Flow Control (Imperial)	All Models	VLVF-007	2
M5 Flow Control	All Models	VLVF-008	2

*Sensor and cable sold separately.

RR MEDIUM-DUTY SERIES

Rotary Actuators

How To Order

CLICK OR SCAN

To view full catalog pages on this product

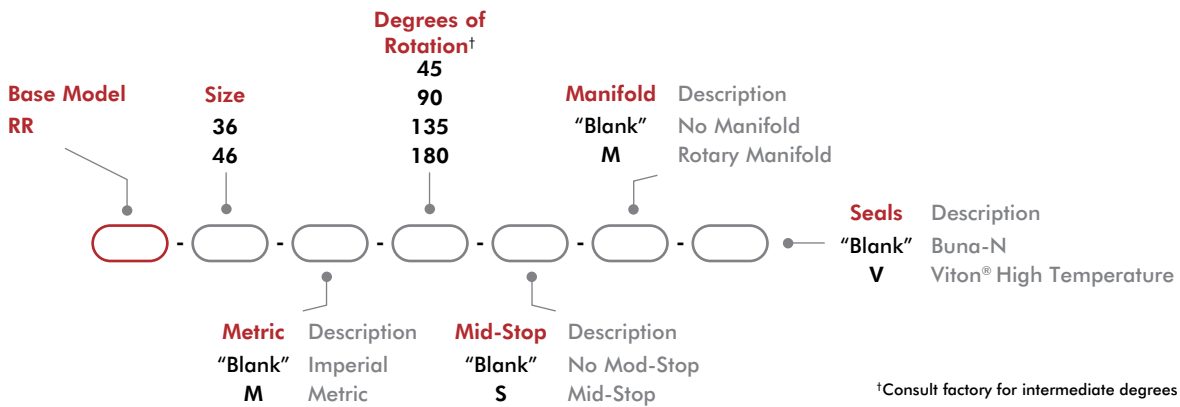

Size	Base Unit Seal Repair Kits		Manifold Seal Repair Kits		Mid-Stop Seal Repair Kits	
	Buna-N	Viton®	-M Buna-N	-M-V Viton®	-S Buna-N	-S-V Viton®
36	SLKT-016	SLKT-016V	SLKT-061	SLKT-061V	SLKT-062	SLKT-062V
46	SLKT-017	SLKT-017V	SLKT-067	SLKT-067V	SLKT-068	SLKT-068V

Basic Unit Dimensions

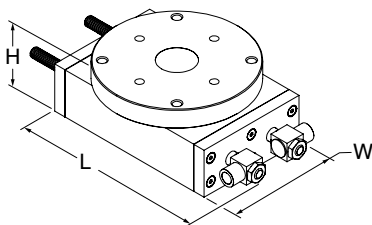

Size	L	W	H
36	170.9 [6.73]	101.6 [4.00]	43.7 [1.72]
46	203.2 [8.00]	113.5 [4.47]	54.1 [2.13]

**CLICK OR SCAN**

To view full catalog pages on this product

RR MEDIUM-DUTY SERIES

Rotary Actuators

Technical Data

Specifications	Units	36	46
Maximum Payload	kg [lb]	3.6 [8.0]	6.8 [15]
Maximum Payload Inertia	Nm sec ² [in-lbs sec ²]	0.00468 [0.0414]	0.01096 [0.0970]
Maximum Rotation		180°	
Maximum Torque Mid-Stroke @ 7 bar [100psi]	Nm [lbs-in]	7.4 [65]	14 [122]
Maximum Torque End-Stroke @ 7 bar [100psi]	Nm [lbs-in]	3.7 [32]	7 [61]
Weight (base unit)	kg [lb]	1.3 [2.9]	2.3 [5]
Weight Adder for Mid-Position Stop	kg [lb]	0.18 [0.4]	0.19 [0.42]
Weight Adder for Rotary Manifold	kg [lb]	0.04 [0.1]	0.17 [0.38]
Pressure Range	bar [psi]	3-7 [40-100]	
Ingress Protection Class (IP)		IP55	
Displacement 180°	cm ³ [in ³]	33.6 [2.05]	63.18 [3.855]
Displacement of Mid-Position Stop	cm ³ [in ³]	19.66 [1.200]	35.95 [2.194]
Temperature Range (Buna-N seals)		-0°~66° [32°~150°]	
Temperature Range (Viton® seals)	°C [°F]		
Actuation Time 180° @ 5,5 bar [80 psi]	sec	0.35	0.41
Actuation Time 90° @ 5,5 bar [80 psi]	sec	0.2	0.36
End-Stop Repeatability		±0.02°	
Mid-Stop Repeatability		±0.5°	
End-Stop Adjustability		60°	
Over Travel (each end)		4°	

Accessories

Sensor Accessories	Model Numbers	Part Number	Qty/Unit
Sensor Mounting Kit (mounts 2 sensors)	All Models	OSMK-024	1
NPN Inductive Sensor with Quick Disconnect*	All Models	OISN-014	1-2
PNP Inductive Sensor with Quick Disconnect*	All Models	OISP-014	1-2
Quick Disconnect 2 Meter Cable Length*	All Models	CABL-010	1-2
Quick Disconnect 5 Meter Cable Length*	All Models	CABL-013	1-2

* Sensor and cable sold separately.

RR HEAVY-DUTY SERIES

Rotary Actuators

How To Order

CLICK OR SCAN

To view full catalog pages on this product

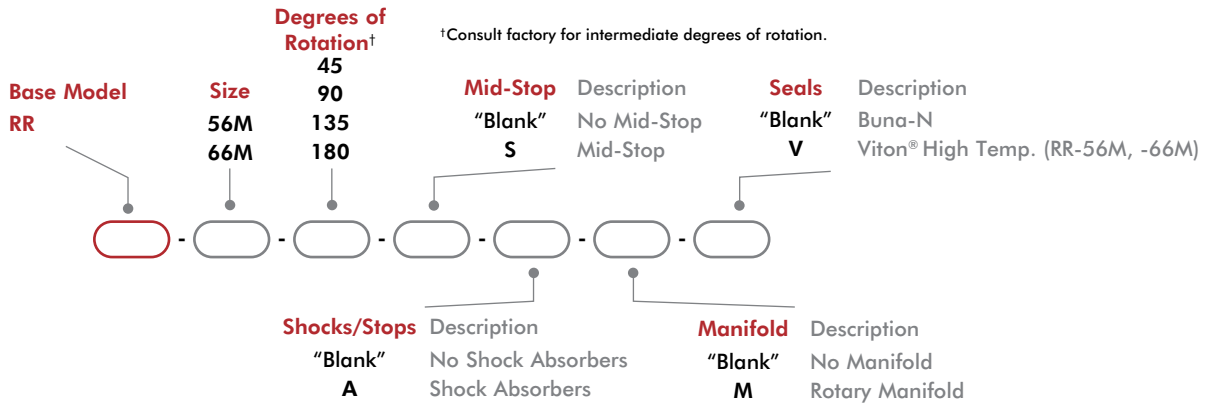
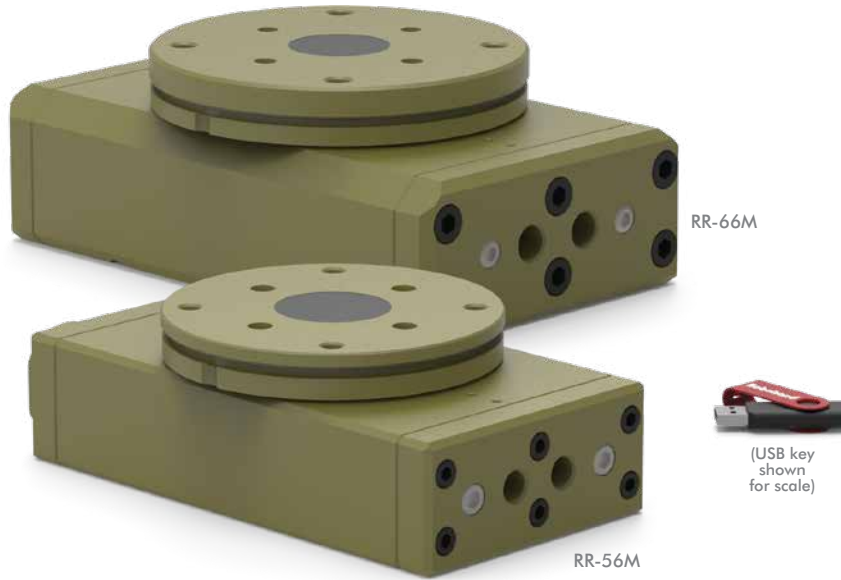

Size	Base Unit Seal Repair Kits		Manifold Seal Repair Kits		Mid-Stop Seal Repair Kits		Shock Seal Repair Kits	
	Buna-N	Viton®	-M Buna-N	-M-V Viton®	-S Buna-N	-S-V Viton®	-A Buna-N	-A-V Viton®
56	SLKT-124	SLKT-124V	SLKT-126	SLKT-126V	SLKT-127	SLKT-127V	SLKT-125	SLKT-125V
66	SLKT-128	SLKT-128V	SLKT-130	SLKT-130V	SLKT-131	SLKT-131V	SLKT-129	SLKT-129V

Basic Unit Dimensions

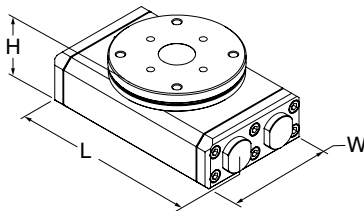

Size	L	W	H
56	[8.50] 215.9	117.5 [4.63]	70.2 [2.77]
66	[10.35] 262.8	158.8 [6.25]	96.8 [3.81]

**CLICK OR SCAN**

To view full catalog pages on this product

RR HEAVY-DUTY SERIES

Rotary Actuators

Technical Data

Specifications	Units	56	66
Maximum Payload†	kg [lb]	13.6 [30]	34 [75]
Maximum Payload Inertia†	Nm sec ² [in-lbs sec ²]	0.02880 [0.2549]	0.11584 [1.0251]
Maximum Rotation		180°	
Maximum Torque Mid-Stroke @ 7 bar [100psi]	Nm [lbs-in]	35 [311]	82 [728]
Maximum Torque End-Stroke @ 7 bar [100psi]	Nm [lbs-in]	17 [155]	41 [364]
Weight (base unit)	kg [lb]	5.3 [11.6]	11.8 [26]
Weight Adder for Mid-Position Stop	kg [lb]	0.82 [1.8]	0.82 [1.8]
Weight Adder for Rotary Manifold	kg [lb]	0.54 [1.2]	0.36 [0.82]
Pressure Range	bar [psi]	3-7 [40-100]	
Displacement	cm ³ [in ³]	160.1 [9.77]	375 [22.8]
Displacement of Mid-Position Stop	cm ³ [in ³]	90.16 [5.502]	60.32 [2.375]
Temperature Range (Buna-N seals)	°C [°F]	0°~66° [-32°~150°]	
Temperature Range (Viton® seals)			
Actuation Time 180° @ 5,5 bar [80 psi]	sec	0.48	0.70
Actuation Time 90° @ 5,5 bar [80 psi]	sec	0.40	0.50
End-Stop Adjustability*		30°	20°
Over Travel (each end)		4°	

†Max. payload based on -A shock option.

*Any adjustment of the End Stop Adjustment Screw must be accompanied by an equal adjustment of the Shock Absorbers to prevent bottoming of the pistons against the Shock Absorbers.

Accessories

Sensor Accessories	Model Numbers	Part Number	Qty/Unit
Inductive Sensor Mounting Kit (mounts 2 sensors)	-56, -66	OSMK-075	1
Magneto Resistive Sensor Mounting Kit (mounts 2 sensors)	-56, -66	OSMK-069	1
NPN Inductive Sensor with Quick Disconnect*	-56, -66	OISN-011	1-2
PNP Inductive Sensor with Quick Disconnect*	-56, -66	OISP-011	1-2
NPN Magneto Resistive Sensor with Quick Disconnect*	-56, -66	OHSN-017	1-2
PNP Magneto Resistive Sensor with Quick Disconnect*	-56, -66	OHSP-017	1-2
Quick Disconnect 2 Meter Cable Length*	-56, -66	CABL-010	1-2
Quick Disconnect 5 Meter Cable Length*	-56, -66	CABL-013	1-2

Pneumatic Accessories	Model Numbers	Part Number	Qty/Unit
G 1/4 BSPP Flow Controls	-56	VLVF-010	2
G 3/8 BSPP Flow Control	-66	VLVF-012	2

*Sensor and cable sold separately.

DLB SERIES - INTERNAL AIR CYLINDER

Internal Air Cylinder Linear Base Slides

CLICK OR SCAN

To view full catalog pages on this product



How To Order

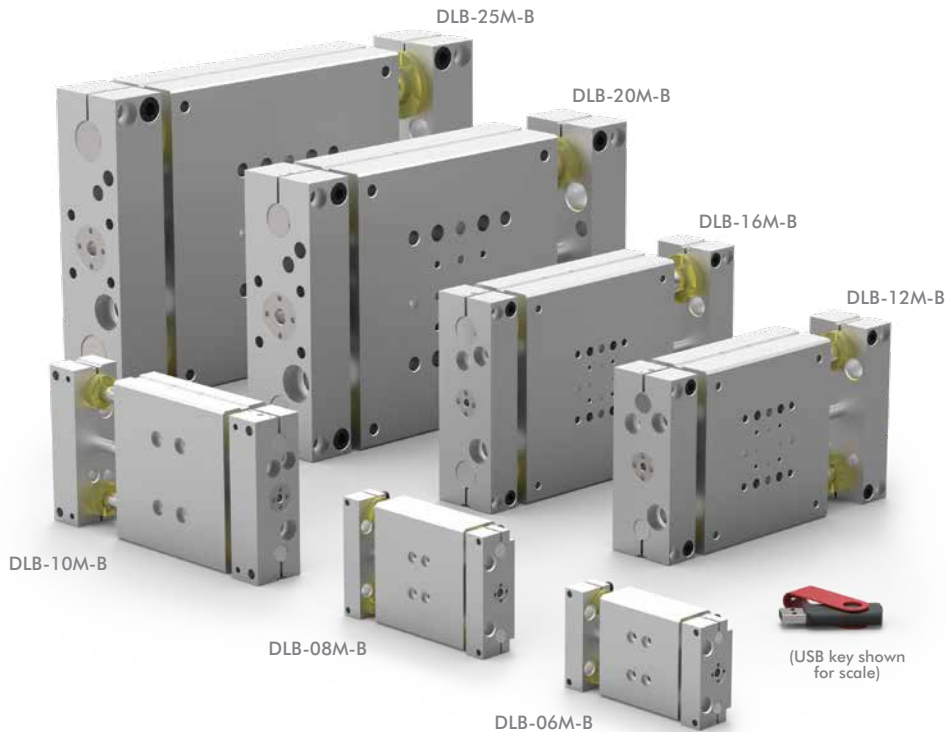

DLB-B series shown above

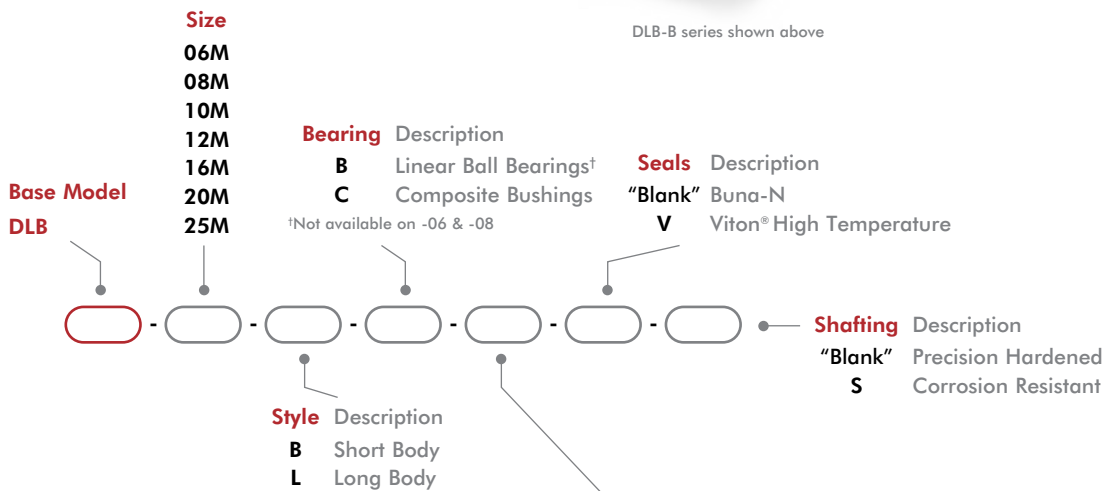

-B Style	Stroke* Metric (mm)
DLB-06M-B	6, 12, 25, 30
DLB-08M-B	6, 12, 25, 40, 44
DLB-10M-B	25, 50
DLB-12M-B	25, 50
DLB-16M-B	25, 50, 80
DLB-20M-B	25, 50, 80, 100
DLB-25M-B	25, 50, 80, 100, 125

-L Style	Stroke* Metric (mm)
DLB-06M-L	12, 25, 40, 50, 65, 75
DLB-08M-L	12, 25, 40, 50, 65, 75, 85
DLB-10M-L	25, 50, 80, 100
DLB-12M-L	25, 50, 80, 100, 125
DLB-16M-L	25, 50, 80, 100, 125, 150
DLB-20M-L	25, 50, 80, 100, 125, 160
DLB-25M-L	25, 50, 80, 100, 125, 160, 175

*Custom strokes available. Consult factory.

*Custom strokes available. Consult factory.



CLICK OR SCAN

To view full catalog pages on this product

DLB SERIES - INTERNAL AIR CYLINDER

Internal Air Cylinder Linear Base Slides

Basic Unit Dimensions

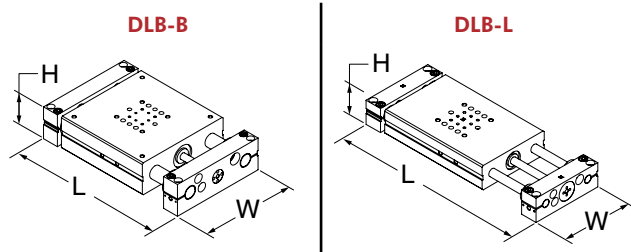

Size	Length - L		W	H
06	81 [3.19]	125.5 [4.94]	50.3 [1.98]	23.7 [0.93]
08	93.7 [3.69]	138.2 [5.44]	62.7 [2.47]	
10	143 [5.63]	193.8 [7.63]	88.6 [3.49]	31.6 [1.24]
12	155.7 [6.13]	219.2 [8.63]	101.2 [3.98]	42.1 [1.66]
16	174.8 [6.88]	244.6 [9.63]	120.3 [4.74]	
20	239.3 [9.42]	290.1 [11.42]	164.6 [6.48]	55.4 [2.18]
25	275.3 [10.84]	326.1 [12.84]	190 [7.48]	

Technical Data

Specifications	Units	06-B, L	08-B, L	10-B, L	12-B, L
Max. Air Pressure	bar [psi]	7 [100]			
Thrust Force @ 5.5 bar [80psi]	N [lbs]	89 [20]		129 [29]	254 [57]
Weight (basic unit) -B	kg [lb]	0.20 [0.44]	0.36 [0.79]	0.93 [2.08]	1.7 [3.83]
Weight (basic unit) -L	kg [lb]	0.32 [0.71]	0.56 [1.24]	1.50 [3.34]	2.30 [5.13]
Additional Weight per Stroke -B	g/mm [lbs/in]	0.53 [0.03]	0.88 [0.05]	1.4 [0.08]	2.1 [0.12]
Cylinder Bore Ø	mm [in]	14.29 [0.563]		19 [0.75]	25 [1.00]
Shaft Ø	mm [in]	6 [0.236]	8 [0.315]	9.5 [0.375]	12 [0.472]

Specifications	Units	16-B, L	20-B, L	25-B, L
Max. Air Pressure	bar [psi]	7 [100]		
Thrust Force @ 5.5 bar [80psi]	N [lbs]	254 [57]	560 [126]	560 [126]
Weight (basic unit) -B	kg [lb]	2.4 [5.19]	5.9 [13.0]	8.2 [18.2]
Weight (basic unit) -L	kg [lb]	3.30 [7.30]	7.1 [15.6]	9.7 [21.4]
Additional Weight per Stroke -B	g/mm [lbs/in]	3.3 [0.19]	5.54 [0.32]	8.4 [0.47]
Cylinder Bore Ø	mm [in]	25 [1.00]	38 [1.5]	38 [1.5]
Shaft Ø	mm [in]	16 [0.630]	20 [0.787]	25 [0.984]

DLB SERIES - INTERNAL AIR CYLINDER

CLICK OR SCAN

To view full
catalog pages
on this product



Internal Air Cylinder Linear Base Slides

Accessories

Shock/Stop Accessories	Model Numbers	Style	Part Number	Qty/Unit	
Shock Absorber	06, 08	ALL	SHOK-030	1-2	
	10		SHOK-028		
	12, 16,		SHOK-010		
	20, -25		SHOK-029		
Adjustable Hard Stop	06, 08	ALL	DLT-0623	1-2	
	10, 12, 16, 20, 25		DLT-1023		
Sensor Accessories	Model Numbers	Style	Part Number	Qty/Unit	
PNP Inductive Sensor with Quick Disconnect*	All Models	ALL	OISP-011	1-2	
NPN Inductive Sensor with Quick Disconnect*			OISN-011		
Quick Disconnect 2 Meter Cable Length*			CABL-010		
Quick Disconnect 5 Meter Cable Length*			CABL-013		
Pneumatic Accessories	Model Numbers	Style	Part Number	Qty/Unit	
G1/8 Telescopic Airlines (up to 50mm)	10, 12, 16	B	OTAL-043	1-4	
G1/8 Telescopic Airlines (up to 80mm)	10, 12, 16		OTAL-044		
G1/8 Telescopic Airlines (up to 100mm)	10, 12, 16	L	OTAL-051		
G1/8 Telescopic Airlines (up to 125mm)	10, 12, 16		OTAL-052		
G1/8 Telescopic Airlines (up to 160mm)	10, 12, 16, 20, 25	L	OTAL-045		
G1/8 Telescopic Airlines (up to 300mm)	20, 25		OTAL-046		
M5 Adjustable Flow Control	06, 08, 10, 12, 16	ALL	VLVF-008	1-2	
G 1/8 Adjustable Flow Control	20, 25		VLVF-005		
Cylinder Seal Kit (Buna-N)	06, 08		ALL	SLKT-109	1
	10			SLKT-101	
	12, 16	SLKT-103			
	20, 25	SLKT-105			
Cylinder Seal Kit (Viton®)	06, 08	ALL	SLKT-109V	1	
	10		SLKT-101V		
	12, 16		SLKT-103V		
	20, 25		SLKT-105V		

*Sensor and cable sold separately.



CLICK OR SCAN
To view full
catalog pages
on this product

DLB SERIES - EXTERNAL AIR CYLINDER

External Air Cylinder Linear Base Slides

How To Order

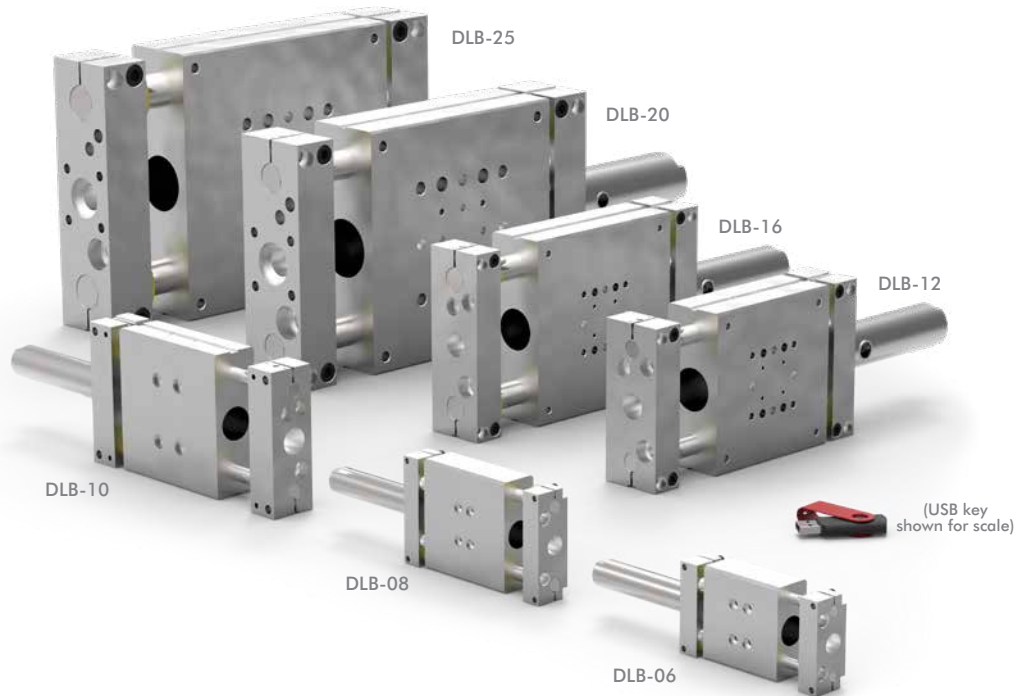

Size	Cylinder Compatibility	
	Imperial	Metric
06	T	T
08	T	T
10	T, A, N	A
12	T, A, N	A
16	T, A, N	A
20	T, A, N	N
25	T, A, N	N

Style*	Description
T	Replaceable cylinder w/o adjustable air cushions
A	Replaceable cylinder with adjustable air cushions
N	Repairable NFPA/VDMA cylinder w/adjustable air cushions

*See chart to the left for cylinder compatibility.

Bearing	Description
B	Linear Ball Bearings*
C	Composite Bushings

*Not available on -06 or -08

Shafting	Description
"Blank"	Precision Hardened
S	Corrosion Resistant

Unit Type	Description
"Blank"	Imperial
M	Metric

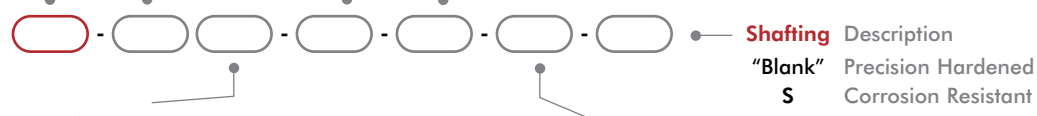

Size	Style	Stroke* Imperial (in)
DLT-06	T	.5, 1, 1.5, 2, 2.5, 3, 4, 5, 6
DLT-08	T	.5, 1, 1.5, 2, 2.5, 3, 4, 5, 6, 7, 8
DLT-10	T, A, N	1-12 @ 1" increments
DLT-12	T, A, N	1-16 @ 1" increments
DLT-16	T, A, N	1-20 @ 1" increments
DLT-20	T, A, N	1-24 @ 1" increments
DLT-25	T, A, N	1-26 @ 1" increments

Size	Style	Stroke* Metric (mm)
DLT-06M	T	10, 25, 40, 50, 75, 100, 125, 160
DLT-08M	T	10, 25, 40, 50, 75, 100, 125, 160, 175, 200
DLT-10M	A	25, 50, 80, 100, 125, 160, 200, 250, 300
DLT-12M	A	25, 50, 80, 100, 125, 160, 200, 250, 300, 320, 360, 400
DLT-16M	A	25, 50, 80, 100, 125, 160, 200, 250, 300, 320, 360, 400, 500
DLT-20M	N	25, 50, 80, 100, 125, 160, 200, 250, 300, 320, 360, 400, 500
DLT-25M	N	25, 50, 80, 100, 125, 160, 200, 250, 300, 320, 360, 400, 500

*Custom strokes available. Consult factory.

DLB SERIES - EXTERNAL AIR CYLINDER

CLICK OR SCAN

To view full
catalog pages
on this product



External Air Cylinder Linear Base Slides

Basic Unit Dimensions

DLB-T

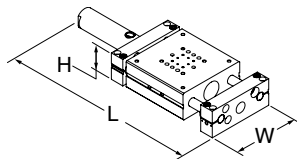

DLB-A

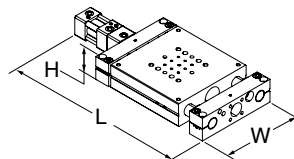

DLB-N

Size		Length - L		W	H
06	129.4 [5.10]	--	--	50.3 [1.98]	23.7 [0.93]
08	142.1 [5.60]	--	--	62.7 [2.47]	
10	237.4 [8.54]	237.4 [9.35]	236.8 [9.07]	88.6 [3.49]	31.6 [1.24]
12	253.6 [9.01]	253.6 [9.98]	249.5 [9.57]	101.2 [3.98]	42.1 [1.66]
16	282.6 [9.76]	272.6 [10.73]	268.5 [10.32]	120.3 [4.74]	56.8 [2.24]
20	315.5 [12.42]	315.5 [12.42]	337.3 [13.28]	164.6 [6.48]	
25	351.5 [13.84]	351.5 [13.84]	373.3 [14.70]	190 [7.48]	

Technical Data

Specifications	Units	06	08	10	12
Max. Air Pressure	bar [psi]	7 [100]			
Thrust Force @ 5.5 bar [80psi]	N [lbs]	89 [20]		145 [31]	289 [65]
Weight (basic unit)	kg [lb]	0.15 [0.34]	0.31 [0.69]	0.90 [1.98]	1.66 [3.73]
Additional Weight per Stroke	g/mm [lbs/in]	0.88 [0.05]	1.23 [0.07]	1.4 [0.09]	2.9 [0.16]
Cylinder Bore Ø	mm [in]	16 [0.563]		20 [0.75]	25 [1.00]
Shaft Ø	mm [in]	6 [0.236]	8 [0.315]	9.5 [0.375]	12 [0.472]
Maximum Moment Load	N-m [in-lbs]	1.7 [15]	3.4 [30]	8.4 [75]	16.9 [150]

Specifications	Units	16	20	25
Max. Air Pressure	bar [psi]	7 [100]		
Thrust Force @ 5.5 bar [80psi]	N [lbs]	289 [65]	578 [130]	578 [130]
Weight (basic unit)	kg [lb]	2.3 [5.03]	5.9 [12.9]	8.3 [18.0]
Additional Weight per Stroke	g/mm [lbs/in]	4.2 [0.23]	9.5 [0.53]	12.1 [0.68]
Cylinder Bore Ø	mm [in]	25 [1.00]	32 [1.25]	32 [1.25]
Shaft Ø	mm [in]	16 [0.630]	20 [0.787]	25 [0.984]
Maximum Moment Load	N-m [in-lbs]	33.9 [300]	67.8 [600]	135 [1200]

**CLICK OR SCAN**

To view full catalog pages on this product

DLB SERIES - EXTERNAL AIR CYLINDER

External Air Cylinder Linear Base Slides

Accessories

Shock/Stop Accessories	Model Sizes	Style	Part Number	Qty/Unit
Shock Absorber	06, 08	All	SHOK-030	1-2
	10		SHOK-028	
	12, 16,		SHOK-010	
	20, 25		SHOK-029	
Adjustable Hard Stop	06, 08		DLT-0623	
	10, 12, 16, 20, 25		DLT-1023	

Sensor Accessories	Model Sizes	Style	Part Number	Qty/Unit
PNP Inductive Sensor with Quick Disconnect*	All Models	All	OISP-011	1-2
NPN Inductive Sensor with Quick Disconnect*			OISN-011	
PNP Magneto Resistive Sensor w/Qk Disconnect*	06, 08, 10, 12, 16	T, A, N	OHSP-005	
NPN Magneto Resistive Sensor w/Quick Disconnect*			OHSN-005	
PNP Magneto Resistive Sensor w/Qk Disconnect*	20, 25	N	OHSP-020	
NPN Magneto Resistive Sensor w/Qk Disconnect*			OHSN-020	
Quick Disconnect 2 Meter Cable Length*	All Models	All	CABL-010	
Quick Disconnect 5 Meter Cable Length*			CABL-013	
Cable Extension Cord 1M Length*	All Models	All	CABL-015	
Cable Extension Cord 2M Length*			CABL-016	

Pneumatic Accessories	Model Sizes	Style	Part Number	Qty/Unit
1/8 NPT Telescopic Airlines (up to 6")	10, 12, 16	All	OTAL-039	1-4
1/8 NPT Telescopic Airlines (up to 12")	10, 12, 16		OTAL-040	
1/8 NPT Telescopic Airlines (up to 18")	10, 12, 16, 20, 25		OTAL-041	
1/8 NPT Telescopic Airlines (up to 24")	20, 25		OTAL-042	
#10-32 NPT Adjustable Flow Control	06, 08		VLVF-007	1-2
1/8 NPT Adjustable Flow Control	10, 12, 16, 20, 25		VLVF-004	
G1/8 Telescopic Airlines (up to 160mm)	10, 12, 16		OTAL-045	1-4
G1/8 Telescopic Airlines (up to 300mm)	10, 12, 16		OTAL-046	
G1/8 Telescopic Airlines (up to 450mm)	10, 12, 16, 20, 25		OTAL-047	
G1/8 Telescopic Airlines (up to 600mm)	20, 25		OTAL-048	
G1/8 Adjustable Flow Control	10, 12, 16, 20, 25	VLVF-005	1-2	
G1/8 Male to 1/8 NPT Adapter	20, 25	PLFT-025		

*Sensor and cable sold separately.

DLT SERIES - INTERNAL AIR CYLINDER

Internal Air Cylinder Linear Thruster Slides

CLICK OR SCAN

To view full catalog pages on this product



How To Order

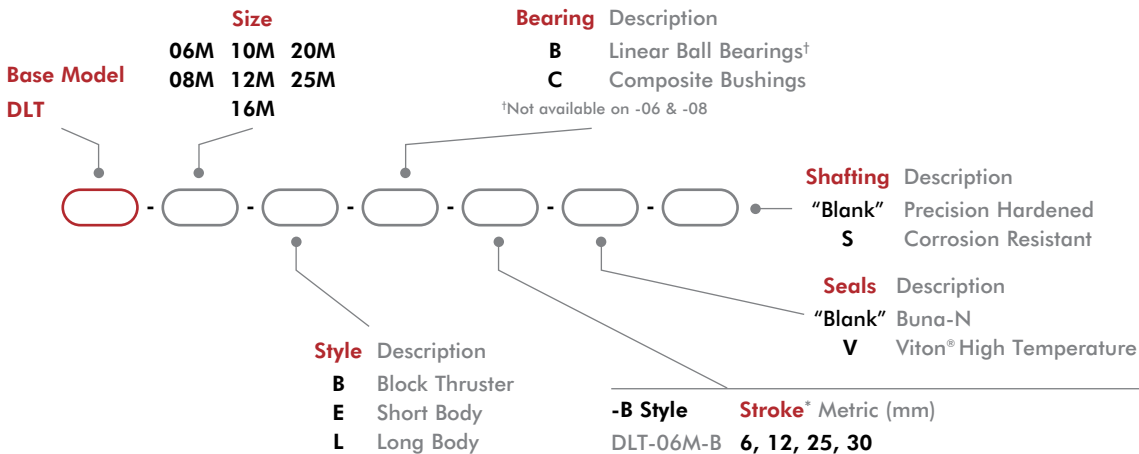
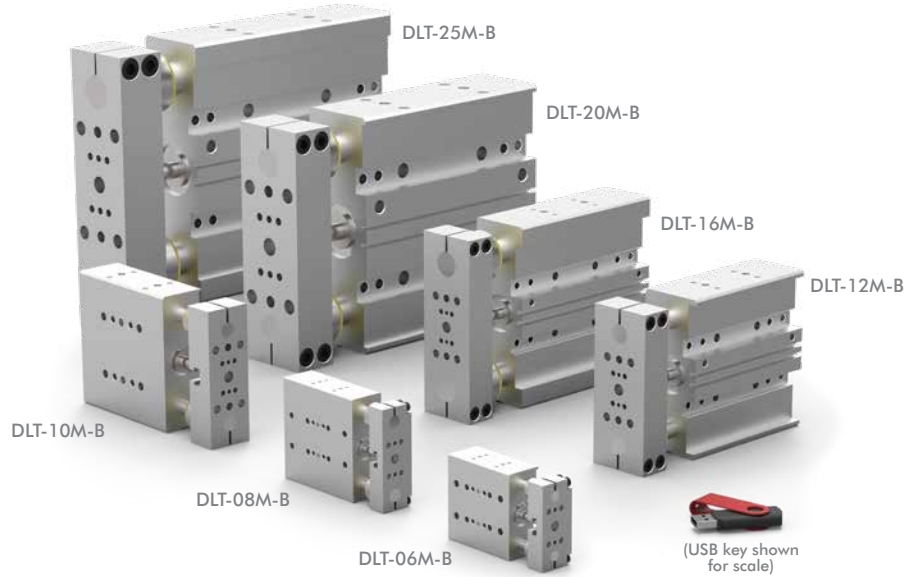

-B Style	Stroke* Metric (mm)
DLT-06M-B	6, 12, 25, 30
DLT-08M-B	6, 12, 25, 30, 40, 44
DLT-10M-B	12, 25, 40, 50
DLT-12M-B	12, 25, 40, 50
DLT-16M-B	12, 25, 40, 50, 65, 75
DLT-20M-B	12, 25, 40, 50, 65, 75, 85, 100
DLT-25M-B	12, 25, 40, 50, 65, 75, 85, 100, 115, 125

-E Style	Stroke* Metric (mm)
DLT-06M-E	6, 12, 25, 30
DLT-08M-E	6, 12, 25, 40, 44
DLT-10M-E	25, 50
DLT-12M-E	25, 50
DLT-16M-E	25, 50, 75
DLT-20M-E	25, 50, 75, 100
DLT-25M-E	25, 50, 75, 100, 125

-L Style	Stroke* Metric (mm)
DLT-06M-L	12, 25, 40, 50, 65, 75
DLT-08M-L	12, 25, 40, 50, 65, 75, 85
DLT-10M-L	25, 50, 80, 100
DLT-12M-L	25, 50, 80, 100, 125
DLT-16M-L	25, 50, 80, 100, 125, 150
DLT-20M-L	25, 50, 75, 100, 125, 160
DLT-25M-L	25, 50, 75, 100, 125, 160, 175

*Custom strokes available. Consult factory.

Size	Base Flange Kit (-B Only)	Cylinder Seal Kits	
		Buna-N	Viton®
06	ODLT-015	SLKT-108	SLKT-108V
08	ODLT-016	SLKT-108	SLKT-108V
10	ODLT-006	SLKT-100	SLKT-100V
12	ODLT-008	SLKT-102	SLKT-102V
16	ODLT-010	SLKT-102	SLKT-102V
20	ODLT-012	SLKT-104	SLKT-104V
25	ODLT-014	SLKT-104	SLKT-104V



CLICK OR SCAN

To view full catalog pages on this product

DLT SERIES - INTERNAL AIR CYLINDER

Internal Air Cylinder Linear Thruster Slides

Basic Unit Dimensions

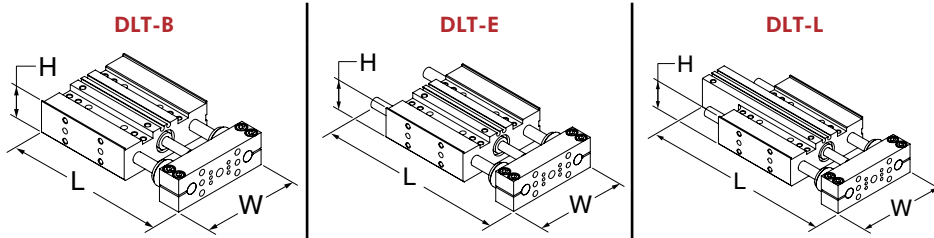

Size		Length - L	W	H
06	100,7 [3.96]	117,5 [4.63]	162,5 [6.40]	50,8 [2.00]
08	114,7 [4.52]	125,1 [4.93]	166,1 [6.54]	22,2 [0.88]
10	172,3 [6.78]	193,1 [7.60]	273,1 [10.75]	29,9 [1.18]
12	185 [7.28]	205,8 [8.10]	323,5 [12.74]	41,0 [1.62]
16	230,6 [9.08]	249,9 [9.84]	375,5 [14.78]	54,4 [2.18]
20	314,9 [12.40]	339,3 [13.36]	430,8 [16.96]	
25	370,6 [14.59]	400,3 [15.76]	471,4 [18.56]	

Technical Data

Specifications	Units	06-B, E	06-L	08-B, E	08-L	10-B, E	10-L	12-B, E	12-L
Max. Air Pressure	bar [psi]	7 [100]							
Thrust Force @ 5.5 bar [80psi]	N [lbs]	89 [20]				155 [35]		275 [62]	
Weight -B (basic unit)	kg [lb]	0.15 [0.34]	--	0.30 [0.65]	--	0.82 [1.81]	--	1.31 [2.88]	--
Weight -E, L (basic unit)	kg [lb]		0.28 [0.61]		0.44 [0.96]	0.84 [1.87]	0.88 [1.95]	1.35 [2.98]	1.46 [3.21]
Cylinder Bore Ø	mm [in]	14.3 [0.563]				19 [0.75]		25 [1.0]	
Shaft Ø	mm [in]	6 [0.236]		8 [0.315]		9.5 [0.375]		12 [0.472]	
Max (M) Vertical Motion	Nm [in-lbs]	0.6 [5]		1.1 [10]		2.8 [25]		5.6 [50]	

Specifications	Units	16-B, E	16-L	20-B, E	20-L	25-B, E	25-L
Max. Air Pressure	bar [psi]	7 [100]					
Thrust Force @ 5.5 bar [80psi]	N [lbs]	275 [62]			622 [140]		
Weight -B (basic unit)	kg [lb]	1.99 [4.38]	--	5.1 [11.6]	--	7.2 [15.7]	--
Weight -E, L (basic unit)	kg [lb]	2.07 [4.56]	2.03 [4.81]	5.2 [11.6]	5.5 [12.0]	7.4 [16.4]	7.9 [17.4]
Cylinder Bore Ø	mm [in]	25 [1.0]			38 [1.5]		
Shaft Ø	mm [in]	16 [0.630]		20 [0.787]		25 [0.984]	
Max (M) Vertical Motion	Nm [in-lbs]	11.3 [100]		28.2 [250]		56.4 [500]	

DLT SERIES - INTERNAL AIR CYLINDER

Internal Air Cylinder Linear Thruster Slides

CLICK OR SCAN

To view full
catalog pages
on this product



Accessories

Shock/Stop & Mounting Accessories	Model Numbers	Style	Part Number	Qty/Unit	
Universal Mounting Kit (Stop/Shock)	06	All	OSAK-069	1-2 on -B	
	08		OSAK-070		
Universal Mounting Kit (Stop/Shock/Sensor)	10		OSAK-055		
	12		OSAK-057		
	16		OSAK-059		
	20		OSAK-061		
	25		OSAK-063		
	06, 08		SHOK-030		
Shock Absorber	10		SHOK-028		1-4 on -E, -L
	12, 16,		SHOK-010		
	20, 25	SHOK-029			
Adjustable Hard Stop	06, 08	DLT-0623			
	10, 12, 16, 20, 25	DLT-1023			
Urethane Bumper/Stop Collar Kit	06	E, L	OSAK-067	1	
	08		OSAK-068		
	10		OSAK-065		
	12		OSAK-066		
	16		OSAK-060		
	20		OSAK-062		
	25	OSAK-064			

Sensor Accessories	Model Numbers	Style	Part Number	Qty/Unit	
Inductive Sensor Mounting Kit	06	All	OSMK-076	1 on -B	
	08		OSMK-077		
PNP Inductive Sensor with Quick Disconnect*	06, 08		OISP-014		
NPN Inductive Sensor with Quick Disconnect*			OISN-014		
PNP Inductive Sensor with Quick Disconnect*	10, 12, 16, 20, 25		OISP-011		1-2 on -E, -L
NPN Inductive Sensor with Quick Disconnect*			OISN-011		
PNP Magneto Resistive with Quick Disconnect*			All Models		
NPN Magneto Resistive with Quick Disconnect*			OHSN-017		1-2
Quick Disconnect 2 Meter Cable Length*	All Models		CABL-010		
Quick Disconnect 5 Meter Cable Length*			CABL-013		

* Sensor and cable sold separately.

Pneumatic Accessories	Model Numbers	Style	Part Number	Qty/Unit	
G1/8 Telescopic Airlines (up to 50mm)	10, 12, 16	B, E	OTAL-043	1-4	
G1/8 Telescopic Airlines (up to 80mm)		B, E, L	OTAL-044		
G1/8 Telescopic Airlines (up to 100mm)	20, 25	B, E	OTAL-051		
G1/8 Telescopic Airlines (up to 125mm)			OTAL-052		
G1/8 Telescopic Airlines (up to 160mm)	10, 12, 16	L	OTAL-045		
G1/8 Telescopic Airlines (up to 300mm)	20, 25		OTAL-046		
M5 Adjustable Flow Control	06, 08, 10, 12, 16	All	VLVF-008		1-2
G1/8 Adjustable Flow Control	20, 25		VLVF-005		



CLICK OR SCAN

To view full catalog pages on this product

DLT SERIES - EXTERNAL AIR CYLINDER

External Air Cylinder Linear Thruster Slides

How To Order

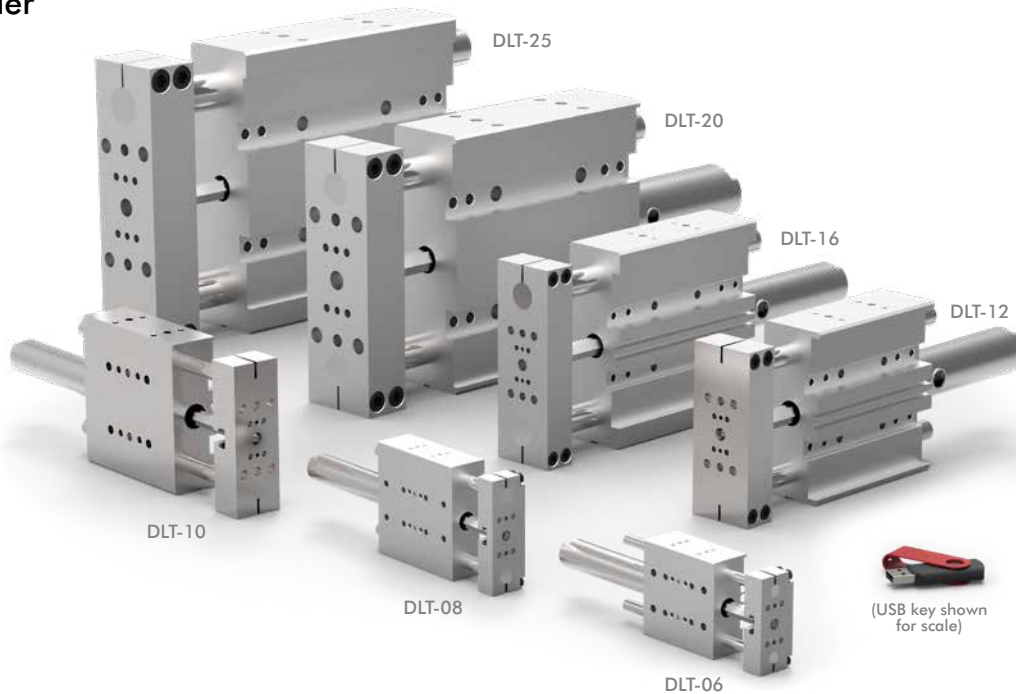

Size	Cylinder Compatibility	
	Imperial	Metric
06	T	T
08	T	T
10	T, A, N	A
12	T, A, N	A
16	T, A, N	A
20	T, A, N	N
25	T, A, N	N

Style*	Description
T	Replaceable cylinder w/o adjustable air cushions
A	Replaceable cylinder with adjustable air cushions
N	Repairable NFPA/VDMA cylinder w/adjustable air cushions

*See chart to the left for cylinder compatibility.

Bearing	Description
B	Linear Ball Bearings*
C	Composite Bushings

*Not available on -06 or -08

Shafting	Description
"Blank"	Precision Hardened
S	Corrosion Resistant

Base Model
DLT



Unit Type Description
"Blank" Imperial
M Metric

Size	Style	Stroke* Imperial (in)
DLT-06	T	.5, 1, 1.5, 2, 2.5, 3, 4, 5, 6
DLT-08	T	.5, 1, 1.5, 2, 2.5, 3, 4, 5, 6, 7, 8
DLT-10	T, A, N	1-12 @ 1" increments
DLT-12	T, A, N	1-16 @ 1" increments
DLT-16	T, A, N	1-20 @ 1" increments
DLT-20	T, A, N	1-24 @ 1" increments
DLT-25	T, A, N	1-26 @ 1" increments

Size	Style	Stroke* Metric (mm)
DLT-06M	T	10, 25, 40, 50, 75, 100, 125, 160
DLT-08M	T	10, 25, 40, 50, 75, 100, 125, 160, 175, 200
DLT-10M	A	25, 50, 80, 100, 125, 160, 200, 250, 300
DLT-12M	A	25, 50, 80, 100, 125, 160, 200, 250, 300, 320, 360, 400
DLT-16M	A	25, 50, 80, 100, 125, 160, 200, 250, 300, 320, 360, 400, 500
DLT-20M	N	25, 50, 80, 100, 125, 160, 200, 250, 300, 320, 360, 400, 500
DLT-25M	N	25, 50, 80, 100, 125, 160, 200, 250, 300, 320, 360, 400, 500

*Custom strokes available. Consult factory.

DLT SERIES - EXTERNAL AIR CYLINDER

CLICK OR SCAN

To view full
catalog pages
on this product



External Air Cylinder Linear Thruster Slides

Basic Unit Dimensions

DLB-T

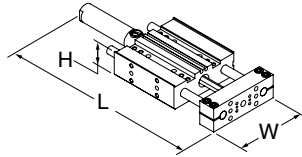

DLB-A

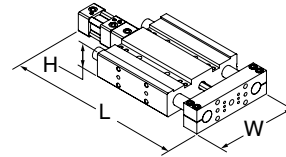

DLB-N

Size		Length - L		W	H
06	125.6 [4.94]	--	--	50.8 [2.00]	
08	138.3 [5.44]	--	--	63.5 [2.50]	22.4 [0.88]
10	210.3 [7.72]	210.3 [8.28]	209.7 [8.25]	88.9 [3.50]	30.2 [1.19]
12	226.5 [8.19]	226.5 [8.92]	222.4 [8.75]	101.6 [4.00]	41.4 [1.63]
16	247.1 [9.01]	247.1 [9.73]	243.0 [9.57]	120.7 [4.75]	
20	291.1 [11.46]	291.1 [11.46]	322.6 [12.70]	165.1 [6.50]	55.9 [2.20]
25	321.8 [12.67]	321.8 [12.67]	353.3 [13.91]	190.5 [7.50]	

Technical Data

Specifications	Units	06	08	10	12	16	20	25
Max. Air Pressure	bar [psi]	7 [100]						
Thrust Force @ 5.5 bar [80psi]	N [lbs]	111 [20]	89 [20]	173 [35]	270 [70]	270 [70]	443 [140]	443 [140]
Weight (basic unit)	kg [lb]	0.24 [0.53]	0.40 [0.88]	1.05 [2.12]	1.64 [3.42]	2.11 [4.47]	6.3 [14.3]	8.5 [19.2]
Additional Weight per Stroke	g/mm [lbs/in]	0.88 [0.05]	1.43 [0.07]	1.2 [0.09]	2.9 [0.15]	4.2 [0.23]	7.9 [0.53]	10.7 [0.68]
Cylinder Bore Ø	mm [in]	16 [0.563]		20 [0.787]	25 [0.984]		32 [1.26]	
Shaft Ø	mm [in]	6 [0.236]	8 [0.315]	9.5 [0.375]	12 [0.472]	16 [0.630]	20 [0.787]	25 [0.984]
Max (M) Vertical Motion	Nm [in-lbs]	0.6 [5]	1.3 [10]	--	--	--	--	--
Min. Air Pressure to Release Cyl. Lock -R	bar [psi]	--	--	--	--	--	4 [60]	
Holding Force of Lock Mechanism -R	N [lbs]	--	--	--	--	--	550 [123]	



CLICK OR SCAN

To view full catalog pages on this product

DLT SERIES - EXTERNAL AIR CYLINDER

External Air Cylinder Linear Thruster Slides

Shock/Stop & Mounting Accessories	Model Numbers	Style	Part Number	Qty/Unit
Universal Mounting Kit (Stop/Shock)	06	All	OSAK-069	1-4
	08		OSAK-070	
	10		OSAK-055	
Universal Mounting Kit (Stop/Shock/Sensor)	12		OSAK-057	
	16		OSAK-059	
	20		OSAK-061	
	25		OSAK-063	
	06, 08		SHOK-030	
	10		SHOK-028	
Shock Absorber (2 Max on -06)	12, 16,		SHOK-010	
	20, 25		SHOK-029	
	06, 08		DLT-0623	
Adjustable Hard Stop	10, 12, 16, 20, 25		DLT-1023	
	06		OSAK-067	
Urethane Bumper/Stop Collar Kit	08		OSAK-068	
	10	OSAK-065		
	12	OSAK-066		
	16	OSAK-060		
	20	OSAK-062		
	25	OSAK-064		

Sensor Accessories	Model Numbers	Style	Part Number	Qty/Unit
Inductive Sensor Mounting Kit	06	T	OSMK-076	1
Inductive Sensor Mounting Kit	08		OSMK-077	
PNP Inductive Sensor with Quick Disconnect*	06, 08	T	OISP-014	
NPN Inductive Sensor with Quick Disconnect*			OISN-014	
PNP Inductive Sensor with Quick Disconnect*	10, 12, 16, 20, 25	T, A, N	OISP-011	
NPN Inductive Sensor with Quick Disconnect*			OISN-011	
PNP Magneto Resistive Sensor w/Qk Disconnect*	06, 08, 10, 12, 16	T, A, N	OHSP-005	1-2
NPN Magneto Resistive Sensor w/Qk Disconnect*			OHSN-005	
PNP Magneto Resistive Sensor w/Qk Disconnect*	20, 25	N	OHSP-020	
NPN Magneto Resistive Sensor w/Qk Disconnect*			OHSN-020	
Quick Disconnect 2 Meter Cable Length*	All Model	All	CABL-010	
Quick Disconnect 5 Meter Cable Length*			CABL-013	
Cable Extension Cord 1M Length*	All Models	All	CABL-015	
Cable Extension Cord 2M Length*			CABL-016	

Pneumatic Accessories	Model Numbers	Style	Part Number	Qty/Unit
1/8 NPT Telescopic Airlines (up to 6")	10, 12, 16	All	OTAL-039	1-4
1/8 NPT Telescopic Airlines (up to 12")	10, 12, 16		OTAL-040	
1/8 NPT Telescopic Airlines (up to 18")	10, 12, 16, 20, 25		OTAL-041	
1/8 NPT Telescopic Airlines (up to 24")	20, 25		OTAL-042	
#10-32 NPT Adjustable Flow Control	06, 08		VLVF-007	
1/8 NPT Adjustable Flow Control	10, 12, 16, 20, 25		VLVF-004	1-2
G1/8 Telescopic Airlines (up to 160mm)	10, 12, 16		OTAL-045	1-4
G1/8 Telescopic Airlines (up to 300mm)	10, 12, 16		OTAL-046	
G1/8 Telescopic Airlines (up to 450mm)	10, 12, 16, 20, 25		OTAL-047	
G1/8 Telescopic Airlines (up to 600mm)	20, 25		OTAL-048	
M5 Adjustable Flow Control	06, 08		VLVF-008	1-2
G1/8 Adjustable Flow Control	10, 12, 16, 20, 25		VLVF-005	

* Sensor and cable sold separately.

Dimensions and technical information are subject to change without notice

DLM SERIES

Miniature Rail Thruster Slide

CLICK OR SCAN

To view full catalog pages on this product



How To Order



Base Model DLM

Bearings Description
 "Blank" Single Bearings
D Double Bearings*
*Not available on DLM-07-12, 09-25, 12-25

Stops Description
 "Blank" None
P Precision Stops

Bore Size **Body Size** **Stroke** Metric (mm)

07M	12	5, 10, 12
	25	12, 15, 20, 25
	38	25, 30, 35, 38
	50	38, 40, 45, 50
09M or 12M	25	5, 10, 15, 20, 25
	50	25, 30, 35, 40, 45, 50
	75	50, 55, 60, 65, 70, 75
	100	75, 80, 85, 90, 95, 100

Size	Seal Repair Kits	
	Base Buna-N	Manifold Kit
07M	SLKT-236	SLKT-239
09M	SLKT-237	SLKT-240
09M	SLKT-238	

Basic Unit Dimensions

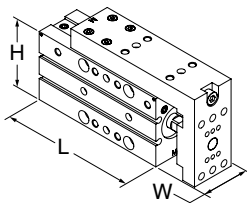

Size	L	W	H
07M-12	78 [3.07]	21 [0.83]	35.5 [1.40]
07M-25	102 [4.02]	21 [0.83]	35.5 [1.40]
07M-38	115 [4.53]	21 [0.83]	35.5 [1.40]
07M-50	127 [5.00]	21 [0.83]	35.5 [1.40]
09M-25	113 [4.45]	32 [1.26]	62 [2.44]
09M-50	159 [6.26]	32 [1.26]	62 [2.44]
09M-75	184 [7.24]	32 [1.26]	62 [2.44]
09M-100	209 [8.23]	32 [1.26]	62 [2.44]
12M-50	126 [4.96]	32 [1.26]	65 [2.56]
12M-75	166 [6.54]	32 [1.26]	65 [2.56]
12M-50	193 [7.60]	32 [1.26]	65 [2.56]
12M-100	218 [8.58]	32 [1.26]	65 [2.56]



CLICK OR SCAN
To view full
catalog pages
on this product

DLM SERIES

Miniature Rail Thruster Slide

Technical Data

Specifications	Units	DLM-07M-12	DLM-07M-25	DLM-07M-38	DLM-07M-50
Thrust Force F @ 7 bar [100 psi]	N [lbs]	66 [15]			
Max. Stroke	mm [in]	12 [0.50]	25 [1.00]	38 [1.50]	50 [2.00]
Stroke Reduction (return)	mm [in]	5 [0.19]			
Weight	kg [lbs]	0.13 [0.28]	0.16 [0.35]	0.20 [0.43]	0.23 [0.50]
Max. Payload W	kg [lbs]	0.45 [1.0]			
Max. Payload W (-P option)	kg [lbs]	0.23 [0.5]			
Cylinder Bore \emptyset	mm [in]	0.11 [0.437]			
Actuation (per 25mm of travel)	sec	0.07			

Specifications	Units	DLM-09M-25	DLM-09M-50	DLM-09M-75	DLM-09M-100
Thrust Force F @ 7 bar [100 psi]	N [lbs]	138 N [31 lbs]			
Max. Stroke	mm [in]	25 [1.00]	50 [2.00]	75 [3.00]	100 [4.00]
Stroke Reduction (return)	mm [in]	5 [0.19]			
Weight	kg [lbs]	0.49 [1.08]	0.64 [1.41]	0.81 [1.78]	0.97 [2.13]
Max. Payload W	kg [lbs]	0.90 [2.0]			
Max. Payload W (-P option)	kg [lbs]	0.45 [1.0]			
Cylinder Bore \emptyset	mm [in]	16 [0.630]			
Actuation (per 25mm of travel)	sec	0.10			

Specifications	Units	DLM-12M-25	DLM-12M-50	DLM-12M-75	DLM-12M-100
Thrust Force F @ 7 bar [100 psi]	N [lbs]	230 [51]			
Max. Stroke	mm [in]	25 [1.00]	50 [2.00]	75 [3.00]	100 [4.00]
Stroke Reduction (return)	mm [in]	5 [0.19]			
Weight	kg [lbs]	0.54 [1.18]	0.65 [1.43]	1.82 [1.80]	1.02 [2.25]
Max. Payload W	kg [lbs]	1.81 [4.0]			
Max. Payload W (-P option)	kg [lbs]	0.90 [2.0]			
Cylinder Bore \emptyset	mm [in]	22 [0.813]			
Actuation (per 25mm of travel)	sec	0.14			

General Specifications	Units	
Temperature Range	°C [°F]	-35°~80° [-30°~180°]
Pressure Range	bar [psi]	1.4-7 [20-100]

Accessories

Sensor Accessories	Model Numbers	Part Number	Qty/Unit
PNP Magneto Resistive Sensor Short Barrel (with Qk. Disc.)*	All Models	OHSP-017	1-4
NPN Magneto Resistive Sensor Short Barrel (with Qk. Disc.)*	All Models	OHSN-017	1-4
PNP Magneto Resistive Sensor 90° Barrel (with Qk. Disc.)*	All Models	OHSP-011	1-4
NPN Magneto Resistive Sensor 90° Barrel (with Qk. Disc.)*	All Models	OHSN-011	1-4
Quick Disconnect 2 Meter Cable Length*	All Models	CABL-010	1-4
Quick Disconnect 5 Meter Cable Length*	All Models	CABL-013	1-4

Pneumatic Accessories	Model Numbers	Part Number	Qty/Unit
Adjustable Flow Control	All Models	VLFL-008	1-2

* Sensor and cable sold separately.

Dimensions and technical information are subject to change without notice

MPS SERIES

Miniature Rail Thruster Slide

How To Order

CLICK OR SCAN

To view full
catalog pages
on this product

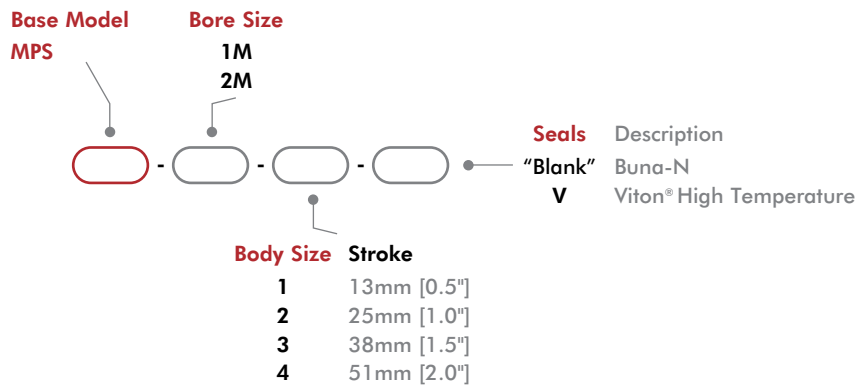
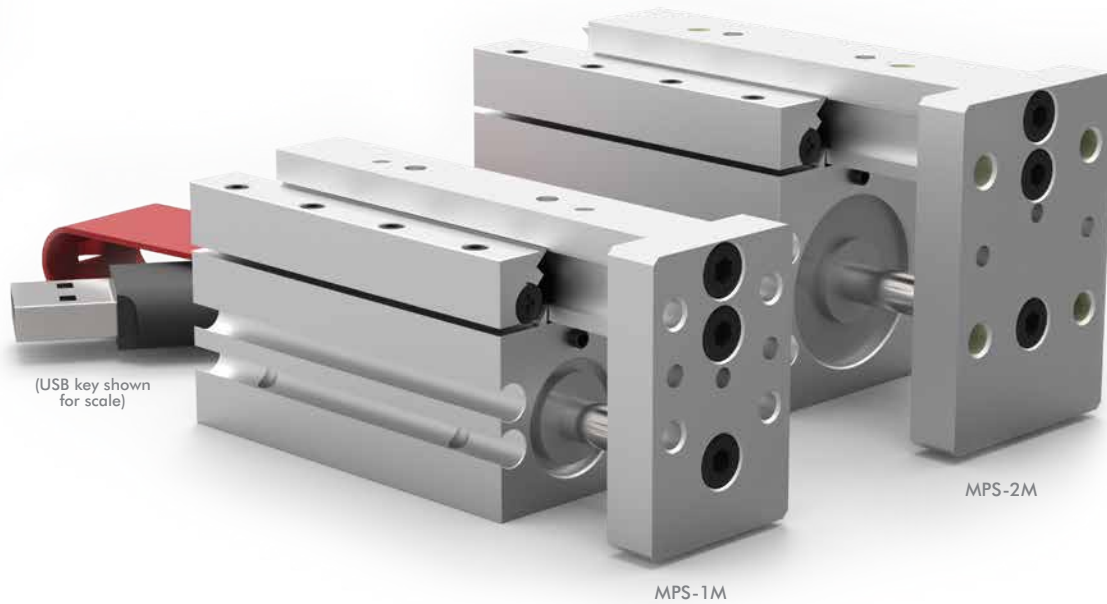

Basic Unit Dimensions

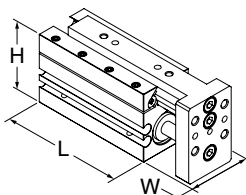

Size	L	W	H
1M-1	46 [1.81]	20.6 [0.81]	31.8 [1.25]
1M-2	63.4 [2.50]	20.6 [0.81]	31.8 [1.25]
1M-3	88.9 [3.50]	20.6 [0.81]	31.8 [1.25]
1M-4	113 [4.45]	20.6 [0.81]	31.8 [1.25]
2M-1	46 [1.81]	27 [1.06]	39.7 [1.56]
2M-2	64.4 [2.54]	27 [1.06]	39.7 [1.56]
2M-3	88.9 [3.50]	27 [1.06]	39.7 [1.56]
2M-4	113 [4.45]	27 [1.06]	39.7 [1.56]

**CLICK OR SCAN**

To view full catalog pages on this product

MPS SERIES

Miniature Rail Thruster Slide

Technical Data

Specifications	Units	1M-1	1M-2	1M-3	1M-4
Thrust Force F @ 7 bar [100 psi]	N [lbs]	67 [15]			
Max. Stroke	mm [in]	13 [0.50]	25 [1.00]	38 [1.50]	51 [2.00]
Stroke Adjustability (each end)	mm [in]	3 [0.12]		6 [0.25]	
Weight	kg [lb]	0.08 [0.18]	0.10 [0.22]	0.13 [0.28]	0.14 [0.32]
Max. Payload W	kg [lb]	0.14 [0.30]	0.32 [0.70]	0.45 [1.00]	0.59 [1.30]
Pressure Range	bar [psi]	1.5-7 [20-100]			
Cylinder Bore Ø	mm [in]	11.1 [0.438]			
Temperature Range (Buna-N seals)	°C [°F]	-35°~80° [-30°~180°]			
Temperature Range (Viton® seals)	°C [°F]	-30°~120° [-20°~250°]			
Actuation	sec	0.10	0.11	0.13	0.14
Linear Accuracy (per 25mm of travel)	mm [in]	±0.003 [±0.0001]			

Specifications	Units	2M-1	2M-2	2M-3	2M-4
Thrust Force F @ 7 bar [100 psi]	N [lbs]	196 [44]			
Max. Stroke	mm [in]	13 [0.50]	25 [1.00]	38 [1.50]	51 [2.00]
Stroke Adjustability (each end)	mm [in]	3 [0.12]		6 [0.25]	
Weight	kg [lb]	0.12 [0.26]	0.14 [0.32]	0.18 [0.40]	0.21 [0.46]
Max. Payload W	kg [lb]	0.23 [0.50]	0.45 [1.00]	0.91 [2.00]	1.36 [3.00]
Pressure Range	bar [psi]	1.5-7 [20-100]			
Cylinder Bore Ø	mm [in]	19.1 [0.750]			
Temperature Range (Buna-N seals)	°C [°F]	-35°~80° [-30°~180°]			
Temperature Range (Viton® seals)	°C [°F]	-30°~120° [-20°~250°]			
Actuation	sec	0.12	0.16	0.19	0.24
Linear Accuracy (per 25mm of travel)	mm [in]	±0.003 [±0.0001]			

Accessories

Sensor Accessories	Model Numbers	Part Number	Qty/Unit
Magneto Resistive Sensor with Quick. Disconnect*	All Models	OHSN-006	1-2
Magneto Resistive Sensor with Quick. Disconnect*		OHSP-006	
Quick Disconnect 2 Meter Cable Length*		CABL-010	
Quick Disconnect 5 Meter Cable Length*		CABL-013	

Pneumatic Accessories	Model Numbers	Part Number	Qty/Unit
M5 Adjustable Flow Control	All Models	VLVF-008	1-2
M2.5 Barbed Fitting		PLFT-005	2
Seal Kit (Buna-N)	-1M	SLKT-090	1
Seal Kit (Viton®)	-1M	SLKT-090V	
Seal Kit (Buna-N)	-2M	SLKT-091	
Seal Kit (Viton®)	-2M	SLKT-091V	

*Sensor and cable sold separately.

RFE SERIES

Feed Escapements

How To Order

CLICK OR SCAN

To view full
catalog pages
on this product

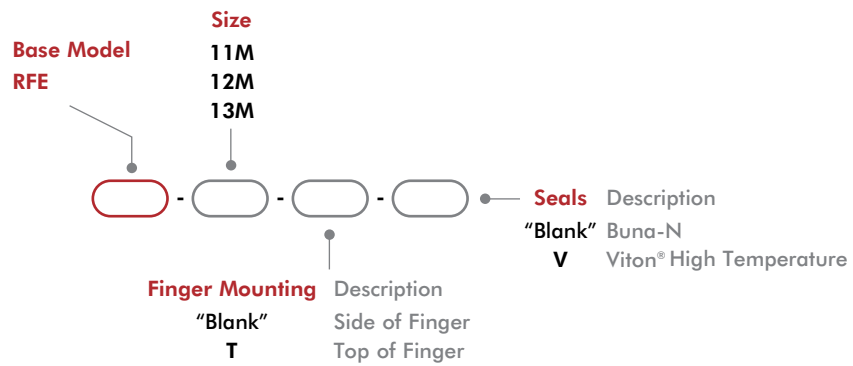
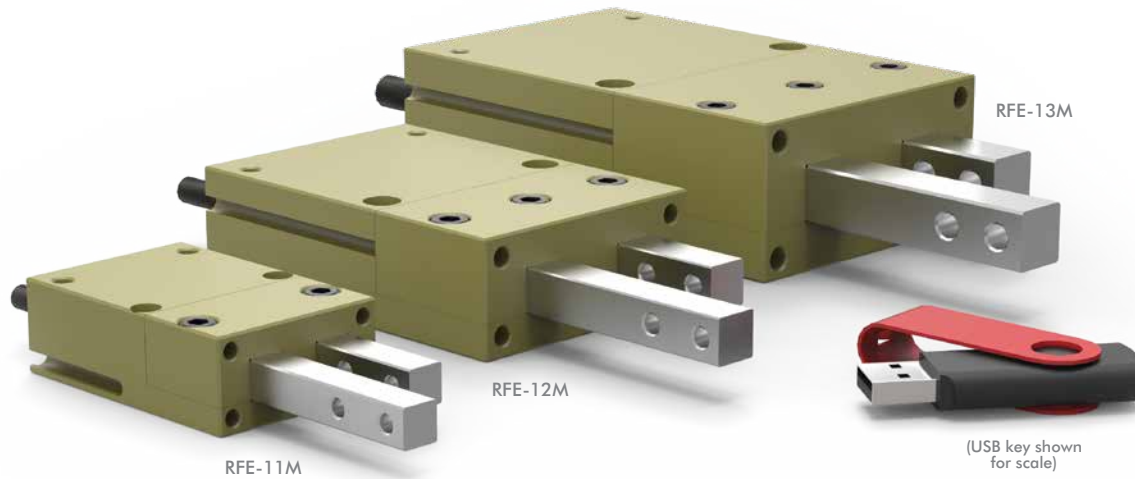

Size	Seal Repair Kits	
	Buna-N	Viton®
11M	SLKT-110	SLKT-110V
12M	SLKT-111	SLKT-111V
13M	SLKT-112	SLKT-112V

**CLICK OR SCAN**

To view full catalog pages on this product

RFE SERIES

Feed Escapements

Basic Unit Dimensions

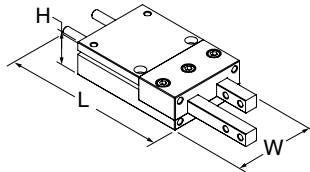

Size	L	W	H
11M	117 [4.59]	38.1 [1.50]	19.1 [0.75]
12M	162 [6.39]	57.2 [2.25]	24.9 [0.98]
13M	197 [7.74]	69.9 [2.75]	34.5 [1.36]

Technical Data

Specifications	Units	11M	12M	13M
Thrust Force @ Maximum PSI	N [lbs]	111 [25]	222 [50]	400 [90]
Stroke	mm [in]	15.88 [0.625]	25.40 [1.000]	31.75 [1.250]
Stroke Adjustability	mm [in]	11 [0.44]	19 [0.75]	19 [0.75]
Weight	kg [lb]	0.15 [0.33]	0.39 [0.85]	0.83 [1.84]
Pressure Range	bar [psi]	3-7 [40-100]		
Cylinder Bore Ø	mm [in]	14.30 [0.563]	20 [0.787]	27 [1.063]
Rod Ø	mm [in]	6.35 [0.250]	7.95 [0.313]	9.52 [0.375]
Displacement	cm ³ [in ³]	2.6 [0.156]	8.0 [0.487]	18.2 [1.108]
Temperature Range (Buna-N seals)	°C [°F]	-35°~80° [-30°~180°]		
Temperature Range (Viton® seals)	°C [°F]	-30°~150° [-20°~300°]		
Actuation	sec	0.40	0.60	0.70
Parts Escaped per Minute		150	100	85
Valve to Actuate		4-way, 2-position		

Accessories

Sensor Accessories	Model Numbers	Part Number	Qty/Unit
NPN Hall Effect Sensor with Quick Disconnect*	All Models	OHSN-017	1-2
PNP Hall Effect Sensor with Quick Disconnect*	All Models	OHSP-017	1-2
Quick Disconnect 2 Meter Cable Length*	All Models	CABL-010	1-2
Quick Disconnect 5 Meter Cable Length*	All Models	CABL-013	1-2

Pneumatic Accessories	Model Numbers	Part Number	Qty/Unit
M5 Adjustable Flow Control	All Models	VLVF-008	1-2

*Sensor and cable sold separately.

RN SERIES

Feed Escapements

How To Order

CLICK OR SCAN

To view full
catalog pages
on this product

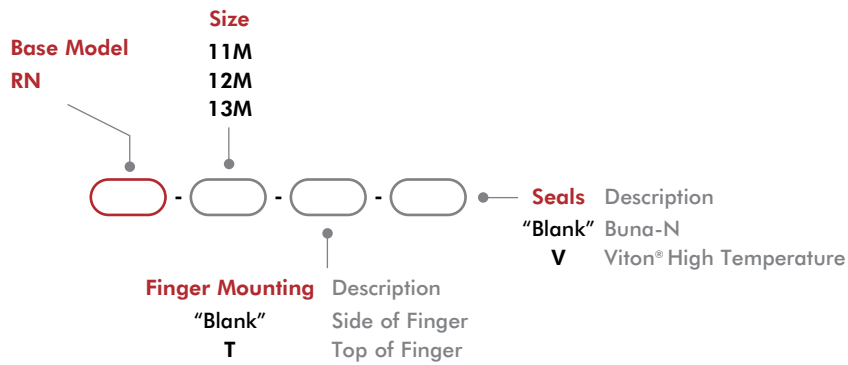

Size	Seal Repair Kits	
	Buna-N	Viton®
11M	SLKT-114	SLKT-114V
12M	SLKT-115	SLKT-115V
13M	SLKT-116	SLKT-116V



CLICK OR SCAN
To view full
catalog pages
on this product

RN SERIES

Feed Escapements

Basic Unit Dimensions

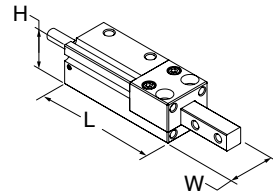

Size	L	W	H
11M	116 [4.59]	22.2 [0.88]	19.1 [0.75]
12M	161 [6.34]	28.6 [1.13]	24.9 [0.98]
13M	195 [7.70]	34.9 [1.38]	34.5 [1.36]

Technical Data

Specifications	Units	11M	12M	13M
Thrust Force @ Maximun PSI	N [lbs]	111 [25]	222 [50]	400 [90]
Stroke	mm [in]	15.88 [0.625]	25.40 [1.000]	31.75 [1.250]
Stroke Adjustability	mm [in]	11 [0.44]	19 [0.75]	19 [0.75]
Weight	kg [lb]	0.09 [0.19]	0.19 [0.42]	0.41 [0.90]
Pressure Range	bar [psi]	3-7 [40-100]		
Cylinder Bore Ø	mm [in]	14.30 [0.563]	20 [0.787]	27 [1.063]
Rod Ø	mm [in]	6.35 [0.250]	7.95 [0.313]	9.52 [0.375]
Displacement	cm ³ [in ³]	1.3 [0.078]	4.0 [0.224]	9.1 [0.554]
Temperature Range (Buna-N seals)	°C [°F]	-35°~80° [-30°~180°]		
Temperature Range (Viton® seals)	°C [°F]	-30°~150° [-20°~300°]		
Actuation	sec	0.14	0.21	0.28
Valve to Actuate		4-way, 2-position		

Accessories

Sensor Accessories	Model Numbers	Part Number	Qty/Unit
NPN Hall Effect Sensor with Quick Disconnect*	All Models	OHSN-006	1-2
PNP Hall Effect Sensor with Quick Disconnect*	All Models	OHSP-006	1-2
Quick Disconnect 2 Meter Cable Length*	All Models	CABL-010	1-2
Quick Disconnect 5 Meter Cable Length*	All Models	CABL-013	1-2

Pneumatic Accessories	Model Numbers	Part Number	Qty/Unit
M5 Adjustable Flow Control	All Models	VLVF-008	1-2

*Sensor and cable sold separately.

NOTES

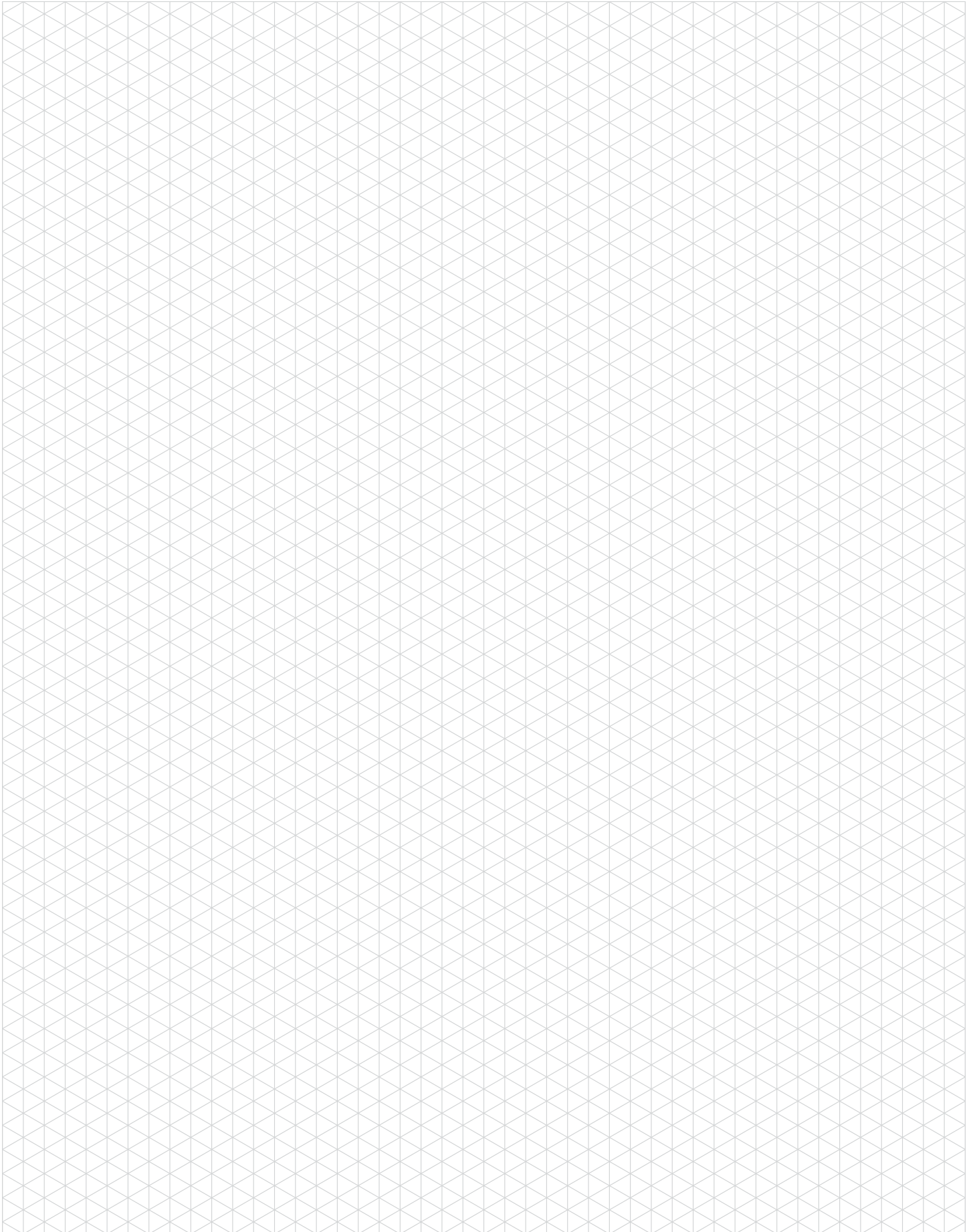

OUR PORTFOLIO OF PRODUCTS



End Effectors (EE)

- Tool Changers
- End-of-Arm Tooling
- Vacuum Products
- Palletizing Solutions



Grippers (GR)

- Electric Grippers
- Pneumatic and Sheet Metal Grippers
- Rotates
- Slides



Indexers (IN)

- Precision Conveyors
- Dial Indexers
- Shaft and Flange Indexers
- Part Handlers

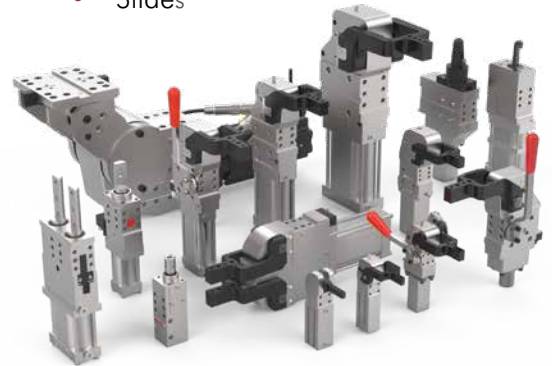

Power Clamps (PC)

- Power Clamps
- Pin Clamps and Packages
- Pivot Units
- Power Cylinders



Manual Clamps (MC)

- Hold Down
- Squeeze Action
- Plunger, Hook and Latch
- Pneumatic Toggle and Swing



Sheet Metal Grippers (SM)

- Accelerate® Press Shop
- Cam Type
- Toggle Lock

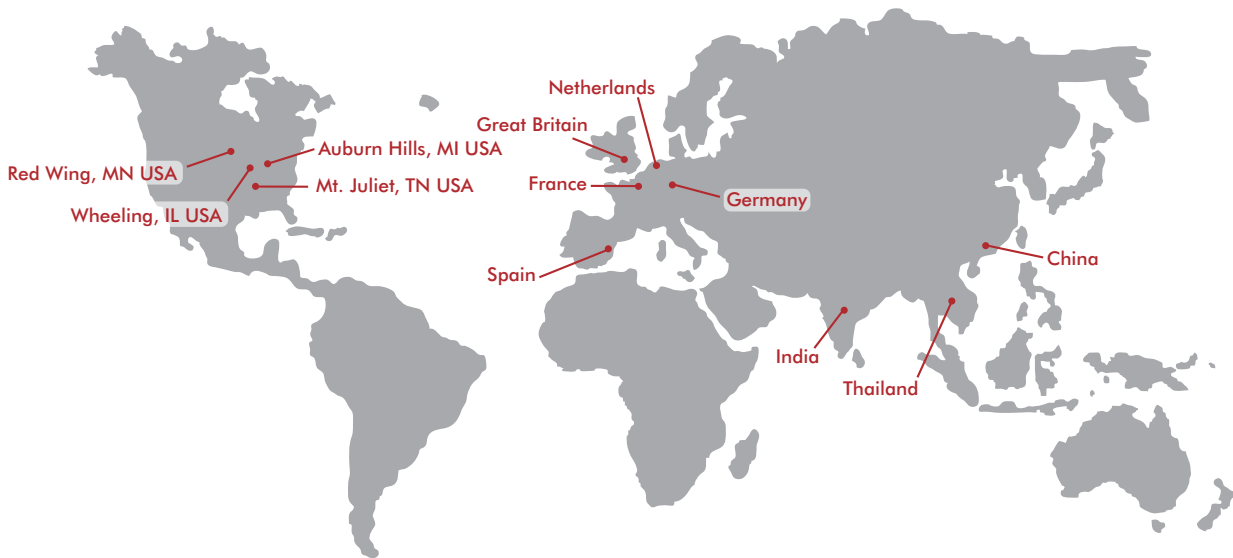

GLOBAL LOCATIONS

NORTH AMERICA

Corporate Headquarters

Auburn Hills, Michigan
Toll Free: 1.888.DESTACO
Marketing: marketing@destaco.com

Global Technology Center

Auburn Hills, Michigan
Tel: 1.248.836.6700
Customer Service: customerservice@destaco.com

Mt. Juliet, Tennessee
Tel: 1.888.DESTACO
Customer Service: customerservice@destaco.com

Wheeling, Illinois
Tel: 1.800.645.5207
Customer Service: camco@destaco.com

Red Wing, Minnesota (Central Research Laboratories)
Tel: 651.385.2142
Customer Service: sales@centres.com

ASIA

Thailand
Tel: +66-2-326-0812
Customer Service: info@destaco.com

China
Tel: +86-21-6081-2888
Customer Service: china@destaco.com

India
Tel: +91-80-41123421-426
Customer Service: india@destaco.com

EUROPE

Germany
Tel: +49-6171-705-0
Customer Service: europe@destaco.com

France
Tel: +33-4-73545001
Customer Service: france@destaco.com

Great Britain
Tel: +44-1902-797980
Customer Service: uk@destaco.com

Spain
Tel: +34-936361680
Customer Service: spain@destaco.com

Netherlands
Tel: +31-297285332
Customer Service: benelux@destaco.com

CLICK OR SCAN
for the latest
PDF version of
this document.

